

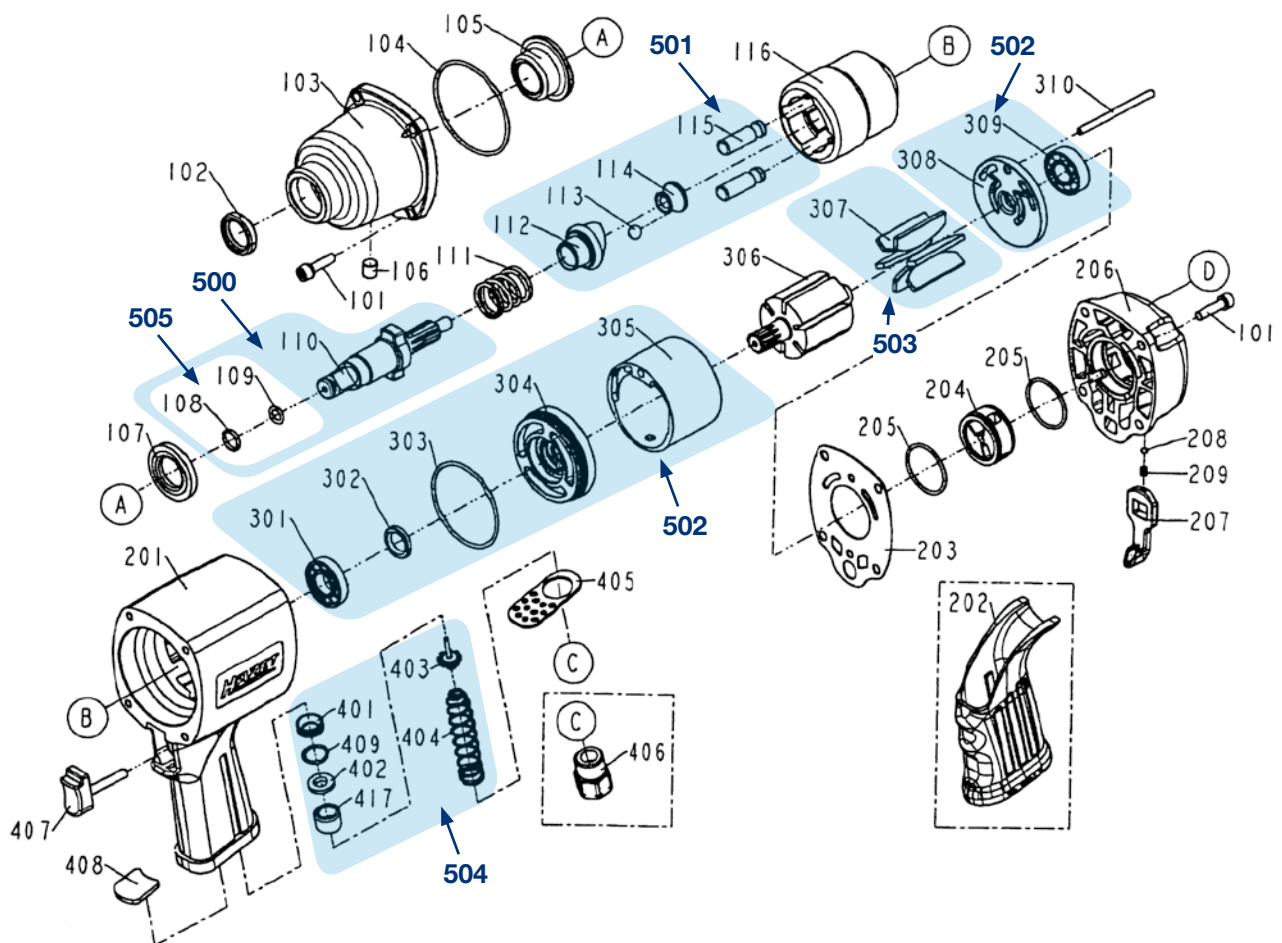



# Erersatzteile 9012 SPC









	Bezeichnung	Name	HAZET No.	
101	Gehäuseschraube	Bolt Assy	120508	Set a'4 Stück
102	Öldichtring	Oil Seal	120514	1
103	Schlagwerkkorb	Hammer Case	120518	1
104	O-Ring	O-Ring	120516	1
105	Schlagwerkkorb-Buchse	Hammer Case Bushing	120519	1
106	Hex. Soc. Hd. Schraube	Hex. Soc Hd. Screw		1
107	Unterlegscheibe	Washer	120521	1
111	Feder	Spring	120506	1
116	Schlagwerkkorb	Hammer Frame		1
201	Gehäuse	Housing		1
202	Haltegriff	Handle Grip		1
203	Gehäuse-Dichtring	Housing Gasket	120507	1
204	Steuerungsventil	Reverse valve	120520	1
205	O-Ring	O-Ring	120515	2
206	Hintere Gehäuseabdeckung	Rear Cover Unit	120510	1
207	Hebel	Lever	120509	1
208	Ventilkugel	Steel Ball	120511	1
209	Feder	Spring	120505	1

	Bezeichnung	Name	HAZET No.	
306	Rotor	Rotor	120517	1
310	Stift	Pin		1
405	Luftleitblech	Exhaust Deflector	120513	1
406	Luftleinlaß	Air Inlet	120512	1
407	Abzughebel	Trigger	120503	1
408	Auslaßsieb	Muffler	120504	1
500	Vierkant	Anvil	9012SPC-01/3	1
	108, 109, 110			
501	Hammer-Set	Stiftschlagwerk	9012SPC-01/5	1
	112, 113, 114, 115, (2)			
502	Zylindereinheit	Cylinder-Set	9012SPC-01/7	1
	301, 302, 303, 304, 305, 308, 309			
503	Lamellen	Blades	9012SPC-01/6	1
	307 (6)			
504	Ventileinheit	Valve-Set	9012SPC-02/6	1
	401, 402, 403, 404, 409, 417			
505	Ringe	Ring-set	9012SPC-01/2	1
	108, 109			
Alle Positionen, die keine <b>HAZET</b> No. haben, sind nur über den HAZET-Service zu erhalten				

Zur Bestellung und für Rückfragen wenden Sie sich bitte an unsere Service-Abteilung.

 +49 (0) 21 91/7 92 355 •  +49 (0) 21 91/7 92 523 •  service-center@hazet.de

**HAZET - WERK Hermann Zerver GmbH & Co. KG** •  10 04 61 • D-42804 Remscheid • Germany  
 +49 (0) 21 91 / 7 92-0 •  +49 (0) 21 91 / 7 92-375 (National) •  +49 (0) 21 91 / 7 92-400 (International)  
 www.hazet.de •  info@hazet.de