

# S45SE09F

## POSITIVE – PLANFRÄSER HIGH POSITIVE FACE MILLING CUTTERS

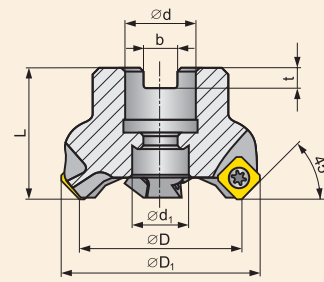

$\varnothing 32 - 125$  mm

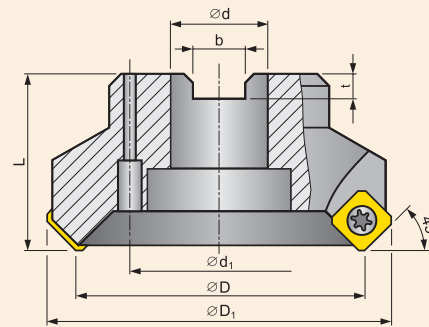

$\varnothing 160$  mm

Z\* – Anzahl Zähne / Number of teeth

$\gamma_p$	+20°	$\kappa_r$	45°
$\gamma_f$	-5°	$a_{p\ max}$	4,5 mm

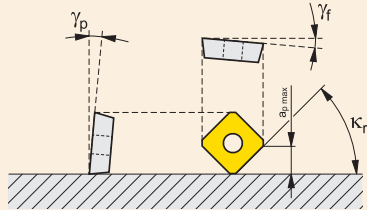

Abmessungen [mm]. / Dimensions [mm].

ISO	Sortiment / Assortment	Abmessungen / Dimensions									Kühlung / Cooling	[kg]	
		D	d	d <sub>1</sub>	L	D <sub>1</sub>	b	t	Z*				
32A04R-S45SE09F-C	○	32	16	14	40	42,0	8,4	6,4	4			+	0,23
40A04R-S45SE09F-C	●	40	16	14	40	53,2	8,4	6,4	4			+	0,34
50A05R-S45SE09F-C	●	50	22	18	40	59,6	10,4	6,4	5			+	0,38
63A05R-S45SE09F-C	●	63	22	18	40	75,8	10,4	6,4	5			+	0,54
63A06R-S45SE09F-C	●	63	22	18	40	75,8	10,4	6,4	6			+	0,56
80A06R-S45SE09F-C	●	80	27	38	50	89,6	12,4	7,0	6			+	1,00
80A08R-S45SE09F-C	●	80	27	38	50	89,6	12,4	7,0	8			+	1,10
100A08R-S45SE09F-C	●	100	32	45	50	110,0	14,4	8,0	8			+	1,38
100A10R-S45SE09F-C	●	100	32	45	50	110,0	14,4	8,0	10			+	1,53
125A09R-S45SE09F-C	●	125	40	60	63	134,5	16,4	9,0	9			+	2,73
125A12R-S45SE09F-C	●	125	40	60	63	134,5	16,4	9,0	12			+	3,12
160C10R-S45SE09F	●	160	40	66,7	63	169,6	16,4	9,0	10				4,73
160C14R-S45SE09F	○	160	40	66,7	63	169,6	16,4	9,0	14				5,10



● Lagersortiment / ○ Kein Lagersortiment  
 ● Stocked as standard / ○ Not stocked as standard  
 Derzeitiges Lagerbestandsortiment ist abhängig von der gültigen Preisliste. / See price list for current availability.

# S45SE09F

POSITIVE – PLANFRÄSER  
INSERTS FOR HIGH POSITIVE FACE MILLS

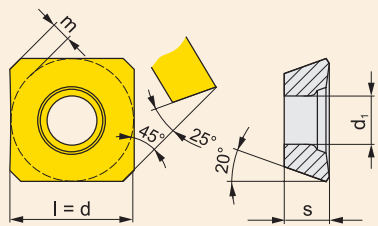

SEMT

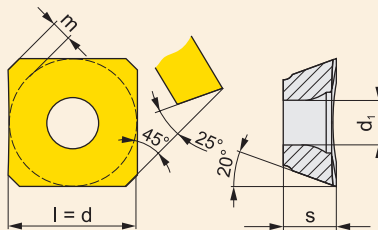

SEET

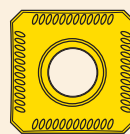

SEMT AFSN

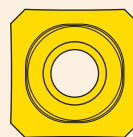

SEET AFEN

## WENDESCHEIDPLATTEN (WSP) / INDEXABLE CUTTING INSERTS

ISO	Materialien / Grades						Abmessungen / Dimensions				
	M9325	M9340	M8340	8215	8230	8240	l	d	s	d <sub>1</sub>	m
SEMT 09T3AFSN	●	●	●	●	●	●	9,525	9,525	3,97	3,50	1,212
SEET 09T3AFEN	●	●	●	●	●	●					

## ERSATZTEILE / SPARE PARTS

\*) Empfohlene Torxschraube – siehe Seite / For screw torques see pages: 394 – 397.

Ø Fräser Ø Cutter	Spannschraube* Clamping screw*	Schraubendreher Screwdriver	Schraube für Messerkopf Screw for taper clamping
32 – 40	US 3007-T09P	SDR T09P	HS 0830C
50 – 63	US 3007-T09P	SDR T09P	HS 1030C
80 – 160	US 3007-T09P	SDR T09P	-



● Lagersortiment / ○ Kein Lagersortiment  
● Stocked as standard / ○ Not stocked as standard  
Derzeitiges Lagerbestandssortiment ist abhängig von der gültigen Preisliste. / See price list for current availability.

PLANFRÄSER  
FACE MILLING CUTTERS

ECKFRÄSER  
SHOULDER END MILLING CUTTERS

WALZENSTIRNFRÄSER/SCHLEIBENFRÄSER  
SQUARE SHOULDER/SLOT MILLING CUTTERS

KOPIERFRÄSER  
COPY MILLING CUTTERS

FRÄSER FÜR SPEZ. ANWENDUNGEN  
CUTTERS FOR SPECIAL APPLICATION

WENDESCHEIDPLATTEN  
INDEXABLE INSERTS