

00029

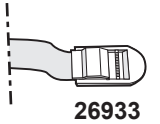

00398

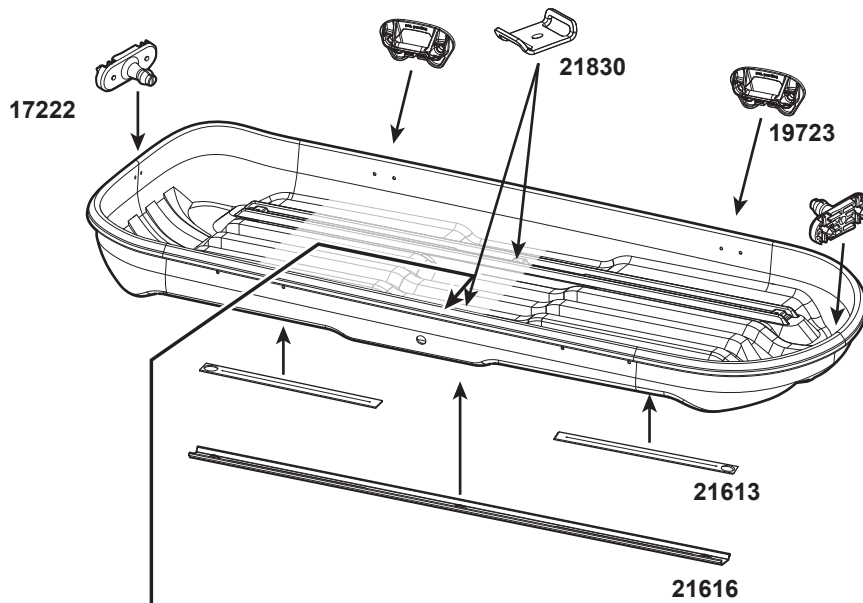

26933

MANUAL



27002

SYSTEM A

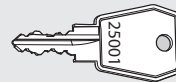
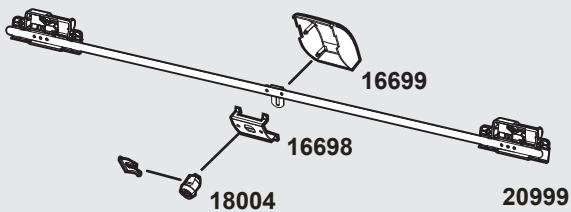

No.:

2	5		
---	---	--	--

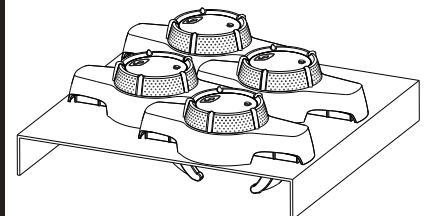

ART.NO: 27000

SYSTEM B

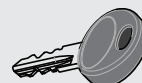
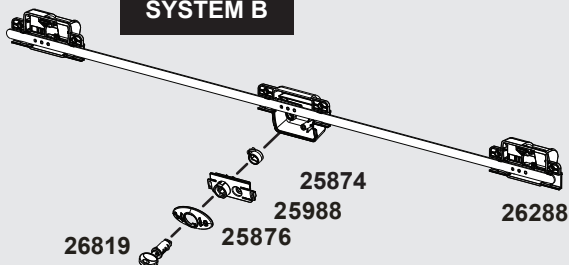

No.:

2			
---	--	--	--

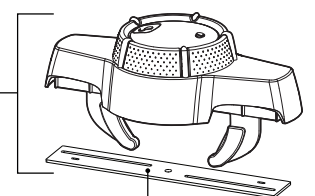

ART.NO: 21612

ART.NO: 27001