

S90S009

SCHULTERFRÄSEN UND NUTFRÄSEN SQUARE SHOULDER AND SLOT MILLING CUTTERS

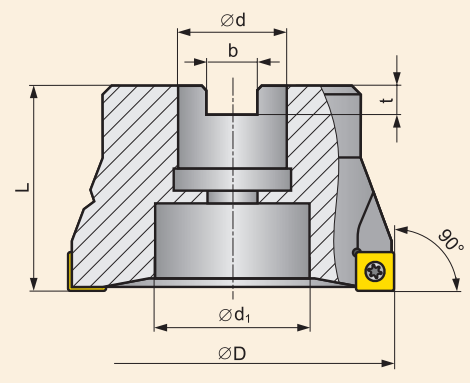

γ_p	+10°	κ_r	90°
γ_f	-8° - -9°	$a_{p\ max}$	8 mm

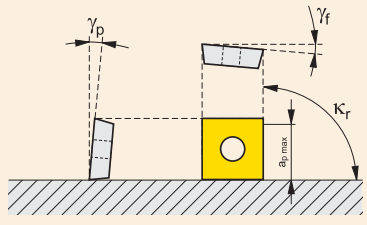

Z* - Anzahl Zähne / Number of teeth

Abmessungen [mm]. / Dimensions [mm].

ISO	Sortiment / Assortment	Abmessungen / Dimensions								Kühlung Cooling	[kg]	
		D	d	d ₁	L	b	t	Z*				
40A05R-S90S009-C	●	40	16	14	40	8,4	5,6	5			+	0,15
50A06R-S90S009-C	●	50	22	18	40	10,4	6,4	6			+	0,30
63A07R-S90S009-C	●	63	22	18	40	10,4	6,4	7			+	0,51
80A09R-S90S009-C	●	80	27	38	50	12,4	7,0	9			+	0,97
100A10R-S90S009-C	●	100	32	45	50	14,4	8,0	10			+	1,61
125A12R-S90S009-C	○	125	40	60	63	16,4	9,0	12			+	2,97



● Lagersortiment / ○ Kein Lagersortiment
● Stocked as standard / ○ Not stocked as standard
Derzeitiges Lagerbestandssortiment ist abhängig von der gültigen Preisliste. / See price list for current availability.

S90S009

SCHULTERFRÄSEN UND NUTFRÄSEN INSERTS FOR SQUARE SHOULDER AND SLOT MILLING CUTTERS

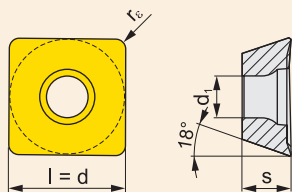

SOMT-P

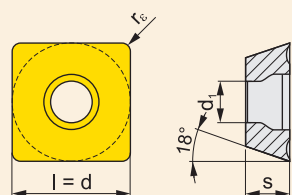

SOMT

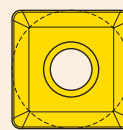

SOMT-P

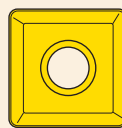

SOMT-MI

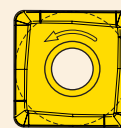

SOMT-M

WENDESCHNEIDPLATTEN (WSP) / INDEXABLE CUTTING INSERTS

ISO	Materialien / Grades								Abmessungen / Dimensions					
	M5315	M9315	M9325	M9340	M8310	M8340	8215	8230	8240	l	d	s	d ₁	r _ε
SOMT 09T304-P			●			●	●	●		9,550	9,550	3,97	3,50	0,4
SOMT 09T304-MI		●		●	●	●	●	●		9,550	9,550	3,97	3,50	0,4
SOMT 09T308-M	●	●				●	●	●		9,550	9,550	3,97	3,50	0,8

ERSATZTEILE / SPARE PARTS

*) Empfohlene Torxschraube – siehe Seite / For screw torques see pages: 394 – 397.

Ø Fräser Ø Cutter	Spannschraube* Clamping screw*	Schraubendreher Screwdriver	Schraube für Messerkopf Screw for taper clamping
40	US 3006-T09P	SDR T09P	HS 0830C
50 – 63	US 3006-T09P	SDR T09P	HS 1030C
80 – 125	US 3006-T09P	SDR T09P	-