

# SSAP-A

## WALZENSTIRNFRÄSER ZUM SCHRUPPEN – NICHT GETEILT HELICAL END MILLING CUTTERS FOR ROUGHING – UNDIVIDED

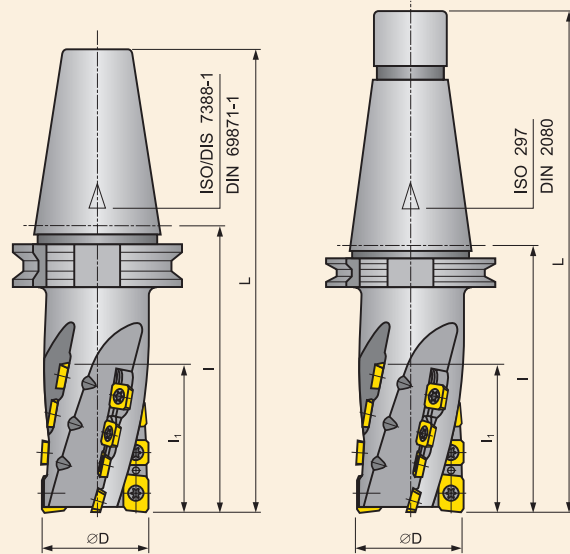

Z\* – Anzahl Zähne / Number of teeth  
 ZN\* – Anzahl der WSP / Number of inserts  
 TS\* – Steilkegelgröße / Taper size

$\gamma_p$	+7°	$\kappa_r$	90°
$\gamma_f$	0°	$a_{p\ max}$	l1

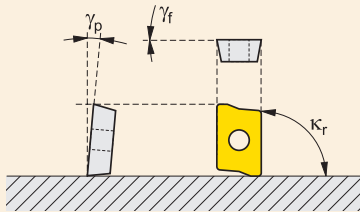

Abmessungen [mm]. / Dimensions [mm].

ISO	Sortiment / Assortment	Abmessungen / Dimensions								Steilkegel Taper	Kühlung Cooling	[kg]
		D	L	l	l <sub>1</sub>	Z*	ZN*	TS*				
50J4R110H50-SSAP58-A	○	50	212	110	58	2+2	2+12	50	ISO/DIS 7388-1		3,5	
50J4R128H50-SSAP76-A	○	50	230	128	76	2+2	2+16	50	ISO/DIS 7388-1		3,8	
63J4R150H50-SSAP95-A	○	63	252	150	95	2+2	2+20	50	ISO/DIS 7388-1		4,5	
80J6R155H50-SSAP95-A	○	80	257	155	95	3+3	3+30	50	ISO/DIS 7388-1		8,0	
50J4R106X50-SSAP58-A	○	50	233	106	58	2+2	2+12	50	ISO 297		3,5	
50J4R124X50-SSAP76-A	●	50	251	124	76	2+2	2+16	50	ISO 297		3,8	
63J4R146X50-SSAP95-A	●	63	273	146	95	2+2	2+20	50	ISO 297		4,5	
80J6R151X50-SSAP95-A	●	80	275	151	95	3+3	3+30	50	ISO 297		8,0	

# SSAP-A

## WALZENSTIRNFRÄSER ZUM SCHRUPPEN – NICHT GETEILT INSERTS FOR END MILLING CUTTERS FOR ROUGHING – UNDIVIDED

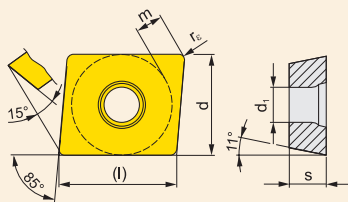

APET / APEW

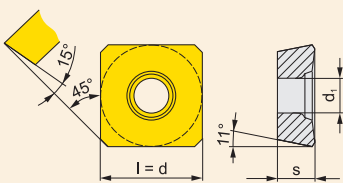

SPET / SPEW

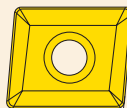

APET EN/SN

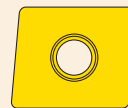

APEW EN/SN

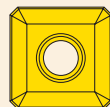

SPET EN/SN

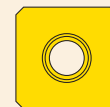

SPEW EN/SN

### WENDESCHNEIDPLATTEN (WSP) / INDEXABLE CUTTING INSERTS

ISO	Materialien / Grades			Abmessungen / Dimensions				
	M8340	8230	8240	(l)	d	s	d <sub>1</sub>	r <sub>ε</sub>
APET 150412EN		●		15,900	12,700	4,76	5,50	1,2
APET 150412SN	●	●	●	15,900	12,700	4,76	5,50	1,2
APEW 150412ER		●	○	15,900	12,700	4,76	5,50	1,2
APEW 150412SR	●	●	○	15,900	12,700	4,76	5,50	1,2
SPET 1204ADEN	●	●	●	12,700	12,700	4,76	5,50	-
SPET 1204ADSN	●	●	●	12,700	12,700	4,76	5,50	-
SPEW 1204ADEN	●	●	○	12,700	12,700	4,76	5,50	-
SPEW 1204ADSN	●	●	●	12,700	12,700	4,76	5,50	-

### ERSATZTEILE / SPARE PARTS

\*) Empfohlene Torxschraube – siehe Seite / For screw torques see pages: 394 – 397.

∅ Fräser ∅ Cutter	Spannschraube* Clamping screw*	Schraubendreher Screwdriver
50, 63, 80	US 4511-T20	SDR T20