

Anwendungshinweis Pneumatik- Schlagschrauber



9013 M



Application Note Pneumatic Impact Wrench



Notice d'utilisation Clé à chocs pneumatique















Toepassingsaanwijzing Pneumatik- Slagmoersleutel



	<i>de</i>	<i>en</i>	<i>fr</i>	<i>nl</i>
	HAZET Pneumatik-Schlagschrauber zum Anziehen und Lösen von Verschraubungen, besonders robuste Ausführung	HAZET Pneumatic Impact Wrench for loosening and tightening screw connections	Clé à chocs pneumatique de HAZET pour serrer et déserrer les vis, exécution robuste	HAZET Pneumatische slagschroevendraaiers voor het aandraaien en losdraaien van schroefverbindingen, zeer robuuste uitvoering.
	Beachten Sie unbedingt die beiliegenden Sicherheitsvorschriften für HAZET-Pneumatikwerkzeuge!	Please observe the enclosed safety instructions for the HAZET pneumatic tools!	Veillez respecter impérativement les consignes de sécurité pour les outils pneumatiques de HAZET !	Neem per se de bijgevoegde veiligheidsvoorschriften in acht voor pneumatische gereedschappen van HAZET!
	Empf. Drehmoment	Recommended torque	Couple recommandé	Aanbevolen moment
	Max. Drehmoment	Max. torque	Couple max.	Maximaal moment
	Max. Lösemoment	Max. loosening torque	Couple de desserrage max.	Maximaal los moment
	Max. Drehzahl/min.	Max. revolutions per minute	Vitesse à vide max. / min.	TPM max.
	Luftverbrauch	Air consumption	Consommation d'air	Lucht-verbruik
	Betriebsdruck	Working pressure	Pression de service	Werkdruk
	Pneumatischer Schlagschrauber, Kupplungsstecker Nennweite 7,2	Pneumatic Impact Wrench, Coupler plug, nominal size 7.2	Clé à chocs pneumatique, Raccord de taille nominale 7.2	Pneumatische slagschroevendraaier, verbindingsstekker, nominale breedte 7,2

Ursprungssprache deutsch – original language: German – Langue d'origine: allemand - Oorspronkelijke taal Duits

Technische Daten / Technical data / Informations techniques / Technische gegevens:

		M32
	m/s ²	7.47
	dB(A)	Lp A 93.0 Lp W 104
	bar	6.3
	l/min.	153
	Ø mm	10
	kg	2.10
	1/min	7300
	Nm	1890
	Nm	1085
	Nm	922
	Ø mm	12,91 (1/2) 7,2
	mm	20 3/4
		
	9013 M	

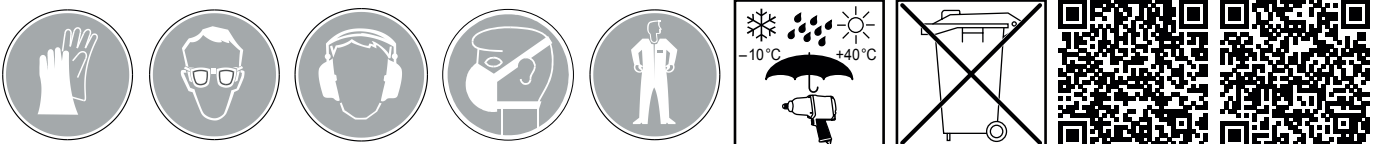
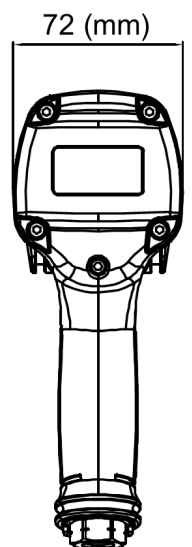
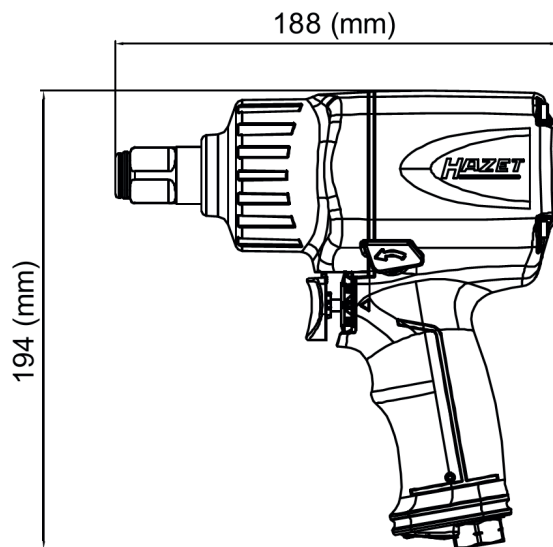

HAZET-WERK Hermann Zerver GmbH & Co. KG •  Güldenwerther Bahnhofstrasse 25-29 • 42857 REMSCHEID
 ✉ 10 04 61 • 42804 REMSCHEID • GERMANY • ☎ +49 (0) 21 91 / 7 92-0
 📠 [FAX] +49 (0) 21 91 / 7 92-375 (Deutschland) -400 (International) • 🌐 www.hazet.de • ✉ info@hazet.de