

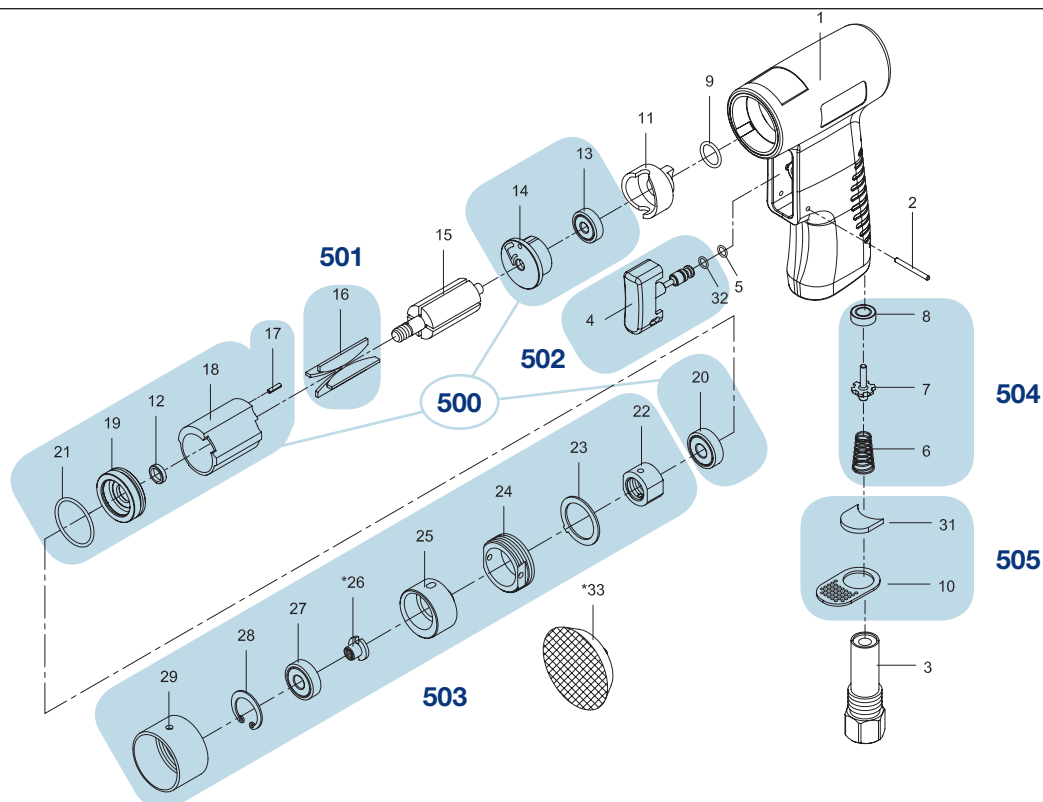

Ersatzteile 9033 N-5



Spare parts - Pièces de rechange



Set	HAZET No.	Bezeichnung	Designation	Désignation	
15	9033N-5-09	Rotor Inhalt: 15	Rotor Contents: 15	Rotor Contenu : 15	1
33	9033N-5-50	Schleifteller Ø 50 mm Inhalt: 33	Grinding disc Ø 50 mm Contents: 33	Plateau de ponçage Ø 50 mm Contenu : 33	1
33*	9033N-5-75	Schleifteller Ø 75 mm Inhalt: 33	Grinding disc Ø 75 mm Contents: 33	Plateau de ponçage Ø 75 mm Contenu : 33	1
500	9033N-5-01/8	Zylindereinheit Inhalt: 12, 13, 14 17, 18, 19, 20, 21	Cylinder unit Contents: 12, 13, 14 17, 18, 19, 20, 21	Unité de vérin Contenu : 12, 13, 14 17, 18, 19, 20, 21	8
501	9033N-5-02/4	Lamellen Inhalt: 16 (4x)	Blades Contents: 16 (4x)	Lamelles Contenu : 16 (4x)	4
502	9033N-03/3	Abzugshebel Inhalt: 4, 5, 32	Trigger Contents: 4, 5, 32	Levier de tirage Contenu : 4, 5, 32	3
503	9033N-5-04/8	Luftmotor Inhalt: 22, 23, 24, 25, 26, 27, 28, 29	Air motor Contents: 22, 23, 24, 25, 26, 27, 28, 29	Moteur pneumatique Contenu : 22, 23, 24, 25, 26, 27, 28, 29	8
504	9033N-05/3	Ventilschaft Inhalt: 6, 7, 8	Valve stem Contents: 6, 7, 8	Tige de soupape Contenu : 6, 7, 8	3
505	9033N-06/5	Luftauslass Inhalt: 10, 31 (4x)	Air exhaust Contents: 10, 31 (4x)	Échappement d'air Contenu : 10, 31 (4x)	5

HAZET - WERK Hermann Zerver GmbH & Co. KG • 10 04 61 • 42804 Remscheid • GERMANY

 +49 (0) 21 91 / 7 92-0 •  +49 (0) 21 91 / 7 92-375 (National) •  +49 (0) 21 91 / 7 92-400 (International)

 Gùldenwerther Bahnhofstraße 25 - 29 • 42857 Remscheid • GERMANY • www.hazet.de •  info@hazet.de

Zubehör 9033 N-5

Accessories - Accessoires

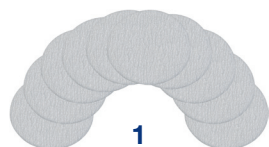

1

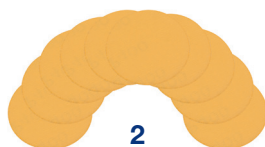

2

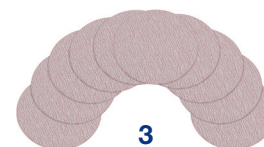

3

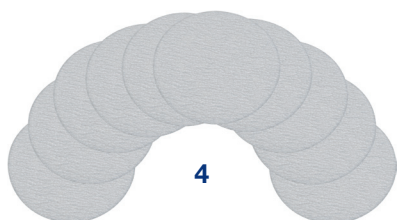

4

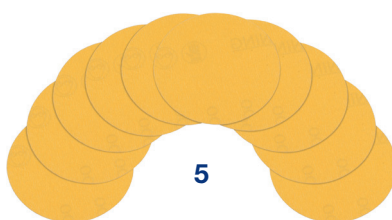

5

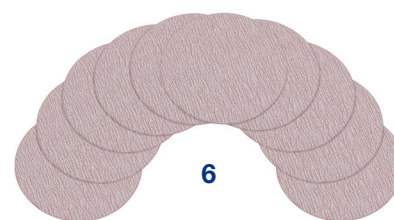

6

Set	HAZET No.	Bezeichnung	Designation	Désignation	
1	9033-5-01/10	Ersatz-Schleifpads Korn 320, Ø 50mm	Spare grinding pads Grain 320, Ø 50mm	Feuilles abrasives de rechange Grain 320, Ø 50mm	10
2	9033-5-02/10	Ersatz-Schleifpads Korn 400, Ø 50mm	Spare grinding pads Grain 400, Ø 50mm	Feuilles abrasives de rechange Grain 400, Ø 50 mm	10
3	9033-5-03/10	Ersatz-Schleifpads Korn 600, Ø 50mm	Spare grinding pads Grain 600, Ø 50mm	Feuilles abrasives de rechange Grain 600, Ø 50 mm	10
4	9033-5-04/10	Ersatz-Schleifpads Korn 320, Ø 75mm	Spare grinding pads Grain 320, Ø 75mm	Feuilles abrasives de rechange Grain 320, Ø 75 mm	10
5	9033-5-05/10	Ersatz-Schleifpads Korn 400, Ø 75mm	Spare grinding pads Grain 400, Ø 75mm	Feuilles abrasives de rechange Grain 400, Ø 75 mm	10
6	9033-5-06/10	Ersatz-Schleifpads Korn 600, Ø 75mm	Spare grinding pads Grain 600, Ø 75mm	Feuilles abrasives de rechange Grain 600, Ø 75 mm	10



HAZET Service Pneumatikmaschinen
www.hazet.de/de/home/service/pneumatikmaschinen



HAZET Ersatzteil-Shop
www.hazet.de/ersatzteil-shop

Zur Bestellung und für Rückfragen wenden Sie sich bitte an unsere Service-Abteilung.
☎ +49 (0) 21 91/7 92 355 • 📠 +49 (0) 21 91/7 92 523 • ✉ service-center@hazet.de

HAZET - WERK Hermann Zerver GmbH & Co. KG • ☒ 10 04 61 • 42804 Remscheid • GERMANY
☎ +49 (0) 21 91 / 7 92-0 • 📠 +49 (0) 21 91 / 7 92-375 (National) • 📠 +49 (0) 21 91 / 7 92-400 (International)
🏠 Güldenwerther Bahnhofstraße 25 - 29 • 42857 Remscheid • GERMANY • 🌐 www.hazet.de • ✉ info@hazet.de