

25906 - Traxer 5.6 Anthra/Anthra

Hapro

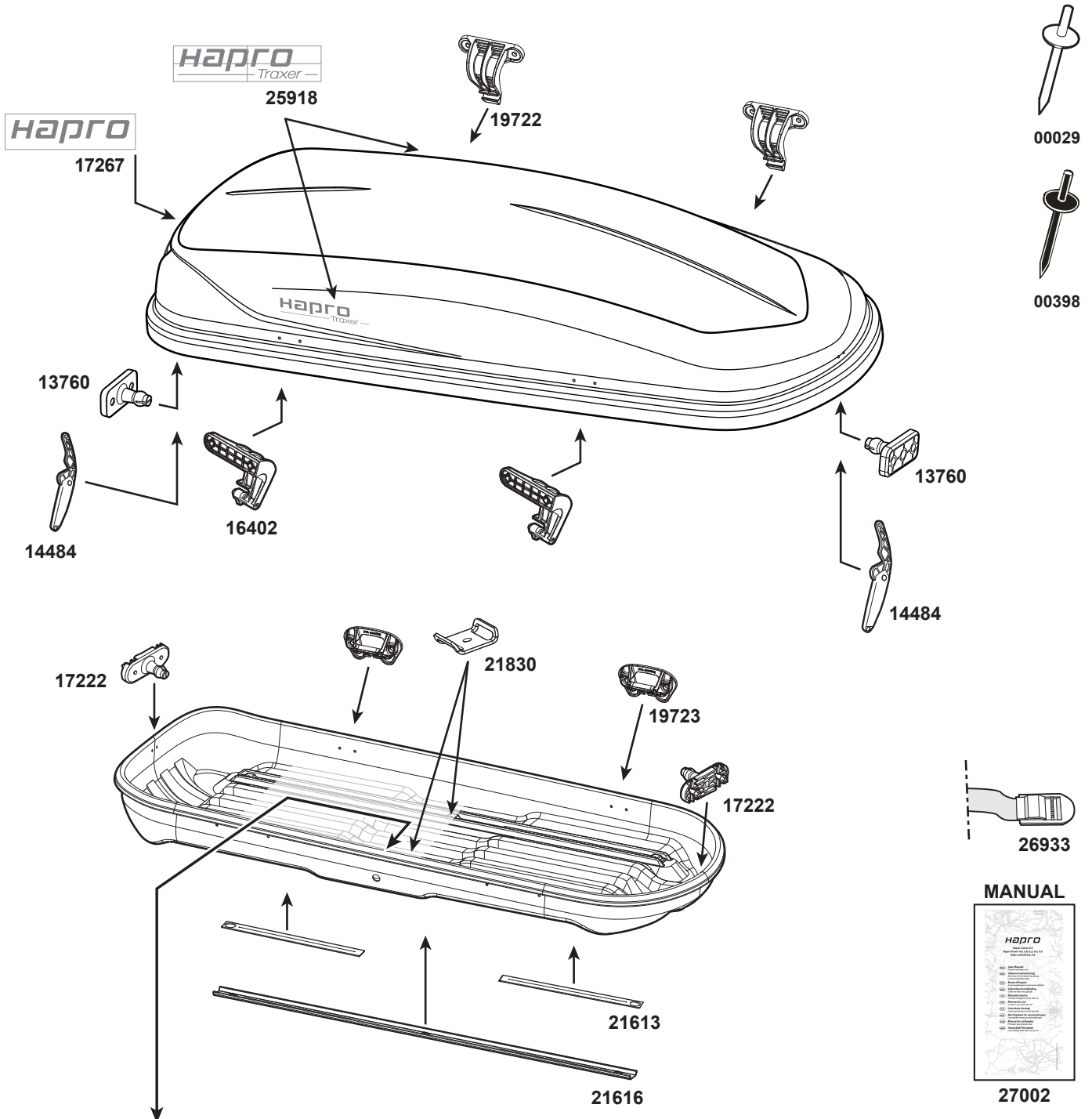

SYSTEM A

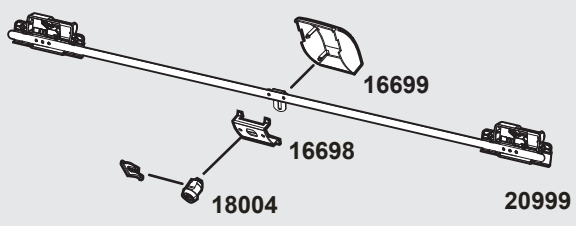

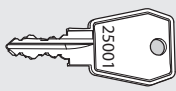
No.: 

2	5		
---	---	--	--

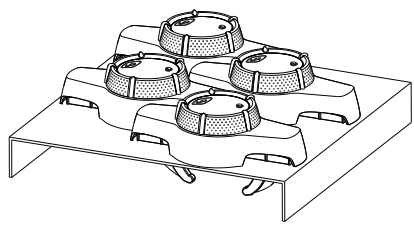

ART.NO: 27000

SYSTEM B

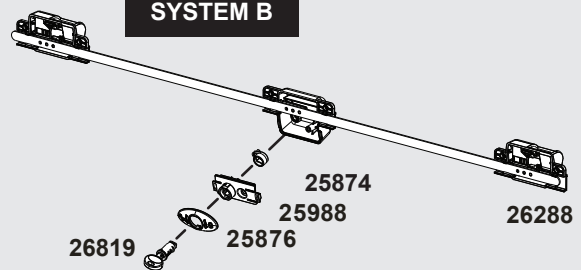

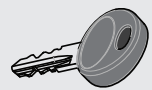
No.: 

2			
---	--	--	--

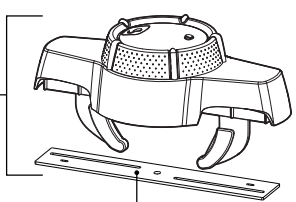

ART.NO: 21612

ART.NO: 27001