

25907 - Traxer 6.2 Anthra/Anthra

HAPRO

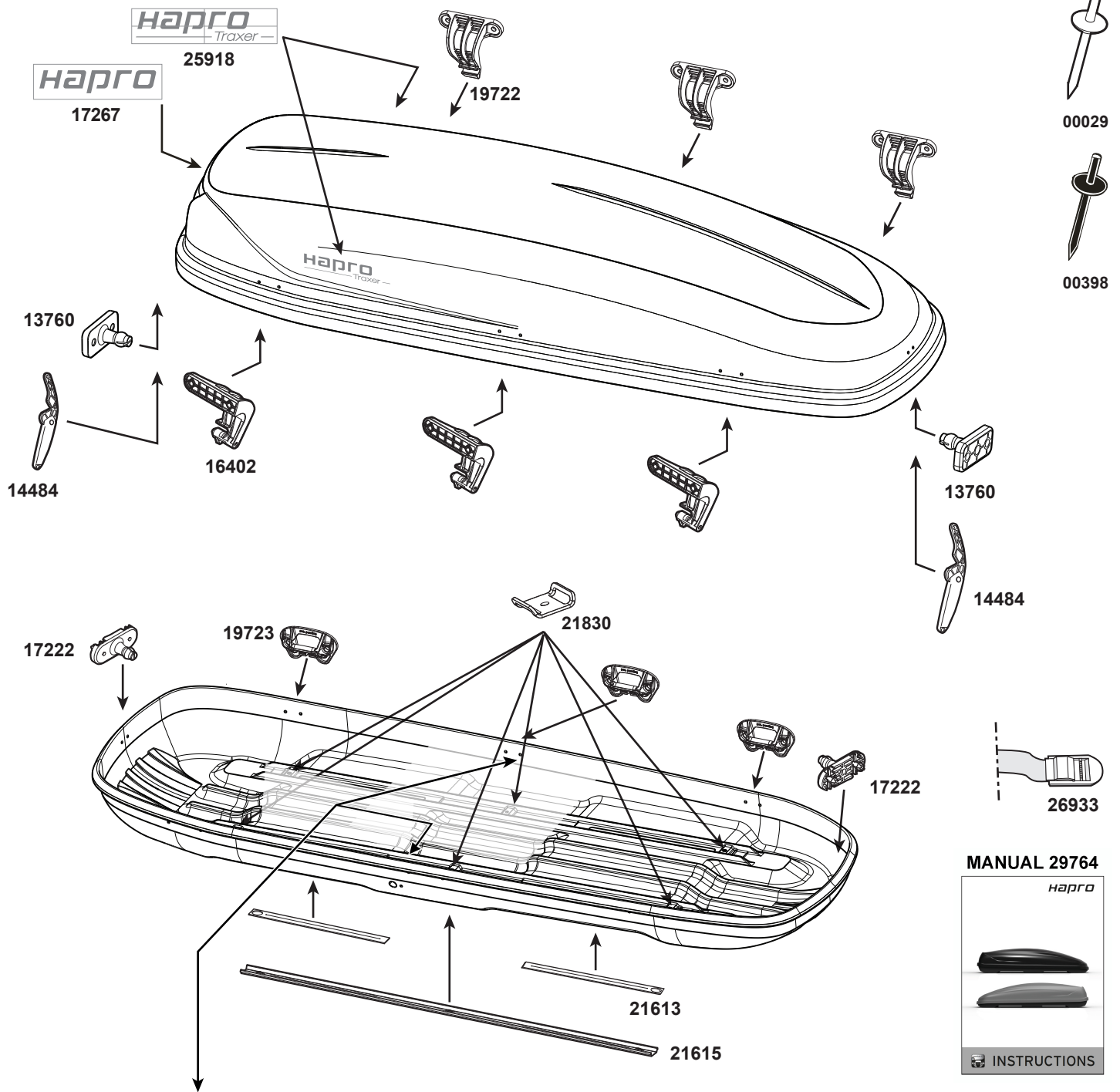

SYSTEM A

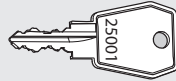
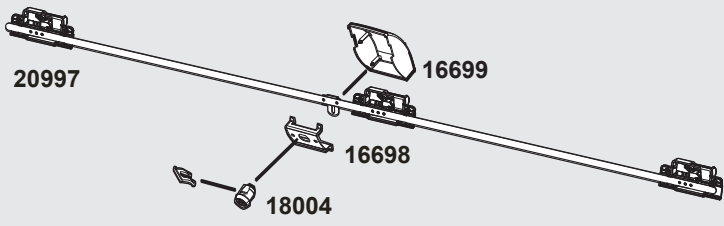

No.:

2	5		
---	---	--	--

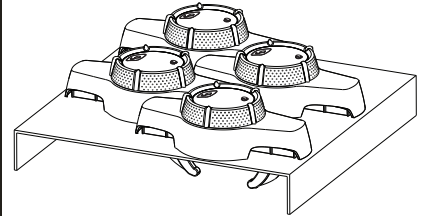

ART.NO: 27000

SYSTEM B

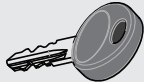
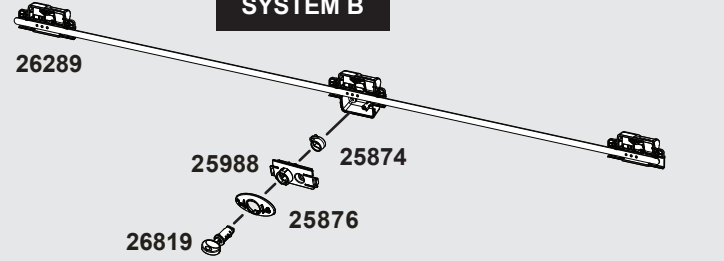

No.:

2			
---	--	--	--

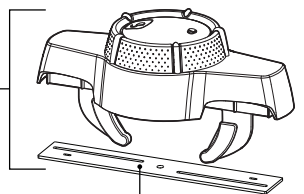

ART.NO: 21612

ART.NO: 27001