



Air Boy® Classic

Robust and impact resistant, infinitely adjustable, leak free

Blowgun with 1000mm straight pipe, ø8mm

The JWL ergonomic design is a classic in itself. We use the compressed air to ease the activation of the handle making it easy, precise and simple to operate.

The Air Boy® Classic is produced in an impact-resistant acetal plastic (POM)

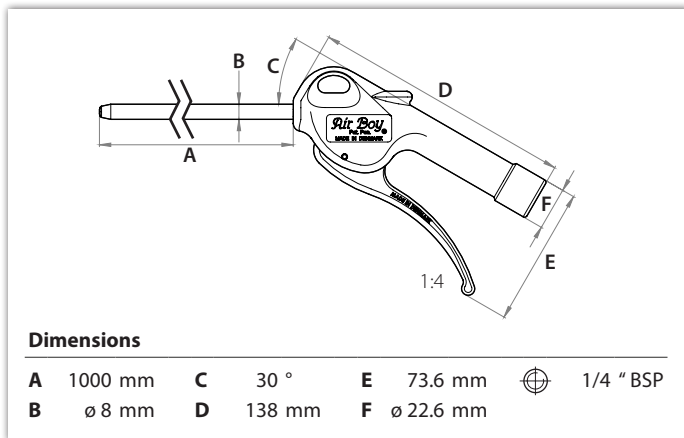

25
Year Warranty
Jahre Garantie
ans de Garantie
años de garantía
års garanti

The durability of our blowguns is top notch - even after 28 million operations. Therefore, we are also proud to offer you a 25 year warranty on the valve system in your Air Boy® blowgun!

Materials		Specifications		Directives		
Handle and trigger	Acetal plastic	Max 16 bar	380 l/min (8 bar)	2003/10/CE	Max 85 dB	OK
Valve	Acetal plastic	85 dB (8 bar), 84 dB (6 bar)	-10°C to +80°C	OSHA 1910.95 (b)	Max 90 dB 8 hr	OK
Gaskets / O-rings	Nitrile	~0,105 kg		OSHA STD 1-13.1	Max 30 psi when blocked	-
Blowing tube & shaft	Steel, el. galvanised					
Spring	Hardened spring wire					

