

 Buitendeuren

 Portes extérieures

 Außentüren

 Exterior doors



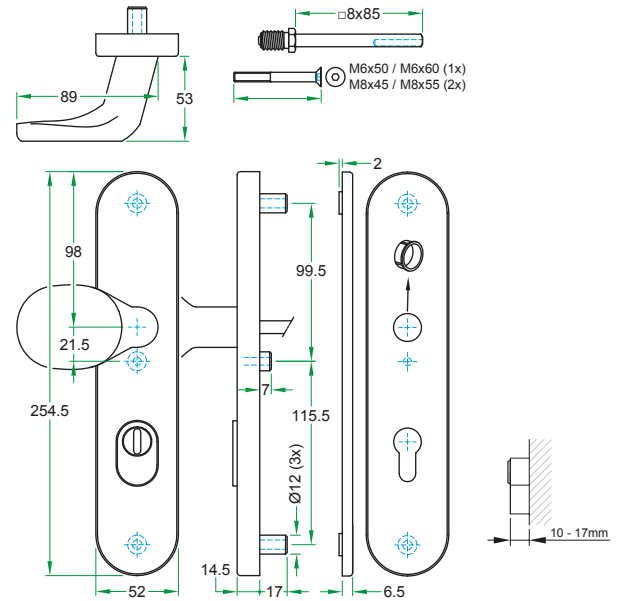
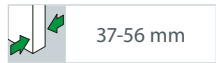

4B



- SKG ***
- Inbraakweerstand kerntrekbeveiliging overtreft SKG*** norm (> 20kN)
- Binnenschild met verdeckte schroefbevestiging
- RVS mat geborsteld
- Incl. 2 schroeven sets t.b.v. DD 37-56 mm
- Deurkruk separaat bestellen



- SKG***
- Resistance cambriolage de la protection de cylindre es supérieur à la norme de SKG*** (> 20kN)
- Plaque interieur avec vis invisible
- Inox mat brossé
- Incl. 2 set de vis pour EP 37-56 mm
- Béquille à commander séparément



- SKG***
- Einbruchwiderstand der Kernziehschutz übersteigt SKG*** Norm (>20kN)
- Innenschild mit verdeckter Schrauben
- Edelstahl matt gebürstet
- Einschl. 2 Schraubensätze für TS 37-56 mm
- Drücker seperat bestellen



- SKG***
- Burglary resistance of cylinder protector supersedes SKG*** norm (>20kN)
- Interior plate with concealed screw fixing
- Satin stainless steel
- Incl. 2 screw sets for doorthickness 37-56 mm
- Order lever seperately



		72 mm	26450/72
		92 mm	26450/92

	0981
--	------

	0982
--	------

	0983
--	------

4B

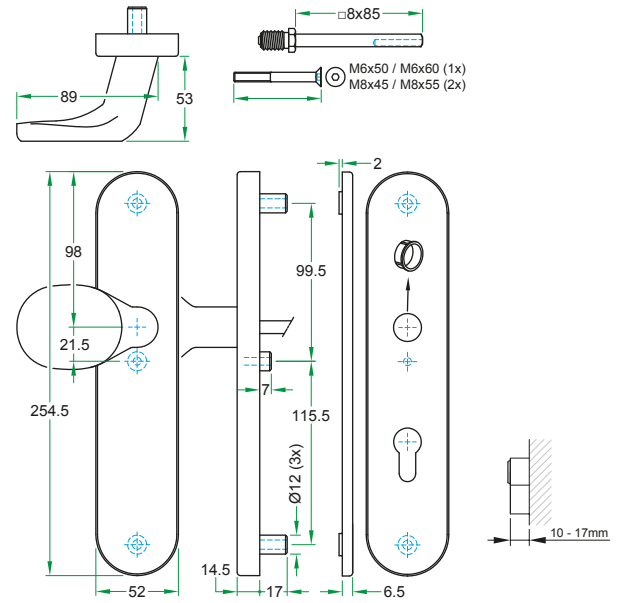
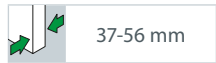

- SKG ***
- Binnenschild met verdeckte schroefbevestiging
- RVS mat geborsteld
- Incl. 2 schroeven sets t.b.v. DD 37-56 mm
- Deurkruk separaat bestellen



- SKG***
- Plaque interieur avec vis invisible
- Inox mat brossé
- Incl. 2 set de vis pour EP 37-56 mm
- Béquille à commander séparément



- SKG***
- Innenschild mit verdeckter Schrauben
- Edelstahl matt gebürstet
- Einschl. 2 Schraubensätze für TS 37-56 mm
- Drücker separat bestellen



- SKG***
- Interior plate with concealed screw fixing
- Satin stainless steel
- Incl. 2 screw sets for doorthickness 37-56 mm
- Order lever separately



		72 mm	26452/72
		92 mm	26452/92



	0981
--	------



	0982
--	------



	0983
--	------

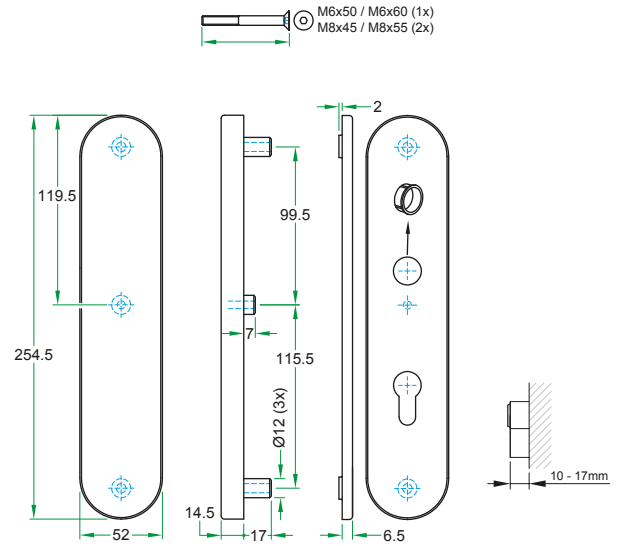
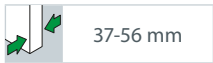

- SKG ***
- Binnenschild met verdeckte schroefbevestiging
- RVS mat geborsteld
- Incl. 2 schroeven sets t.b.v. DD 37-56 mm
- Deurkruk separaat bestellen



- SKG***
- Plaque interieur avec vis invisible
- Inox mat brossé
- Incl. 2 set de vis pour EP 37-56 mm
- Béquille à commander séparatement



- SKG***
- Innenschild mit verdeckter Schrauben
- Edelstahl matt gebürstet
- Einschl. 2 Schraubensätze für TS 37-56 mm
- Drücker separat bestellen



- SKG***
- Interior plate with concealed screw fixing
- Satin stainless steel
- Incl. 2 screw sets for doorthickness 37-56 mm
- Order lever separately



		72 mm	26454/72
		92 mm	26454/92

	0981
--	------

	0982
--	------

	0983
--	------

	\square 8 x 61 mm		38 - 48 mm	93166
	\square 8 x 71 mm		49 - 59 mm	93167
	\square 8 x 82 mm		60 - 70 mm	93168
	\square 10 x 25 mm / \square 8 x 46 mm		49 - 59 mm	93213
	\square 10 x 25 mm / \square 8 x 57 mm		60 - 70 mm	93214

4B

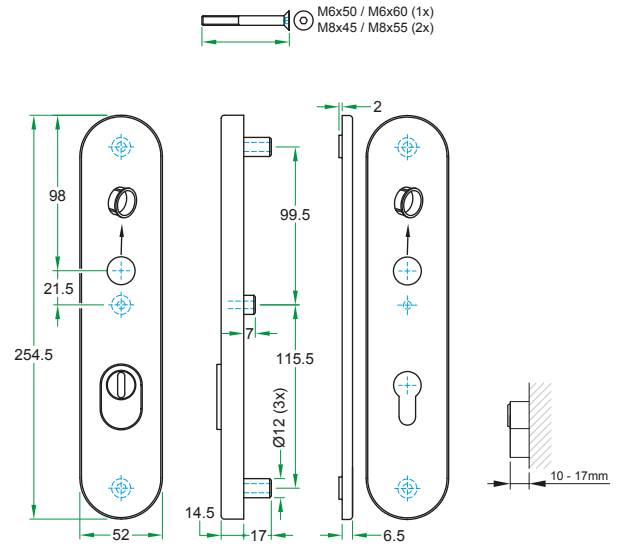
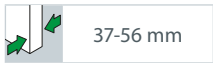
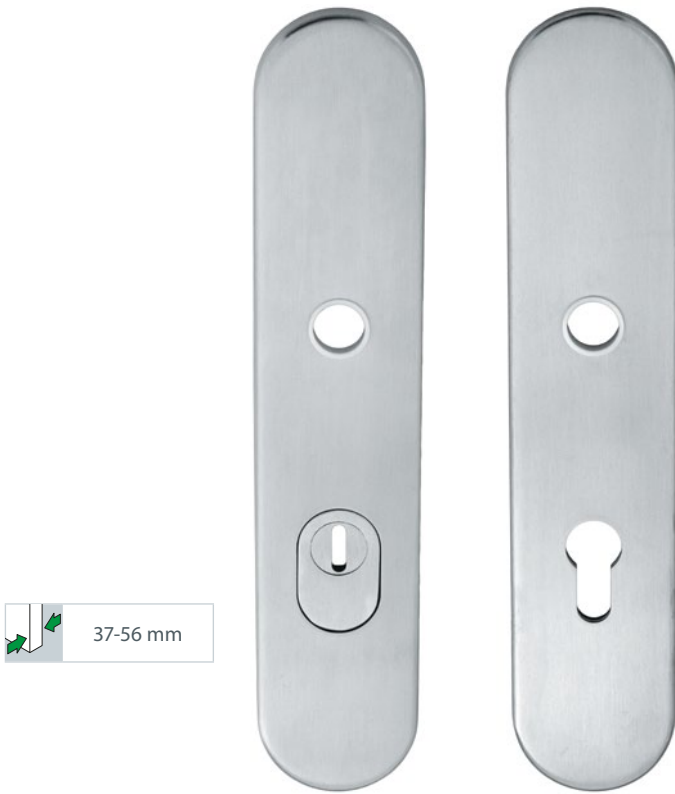

- SKG ***
- Inbraakweerstand kerntrekbeveiliging overtreft SKG*** norm (> 20kN)
- Binnenschild met verdeckte schroefbevestiging
- RVS mat geborsteld
- Incl. 2 schroeven sets t.b.v. DD 37-56 mm
- Deurkruk separaat bestellen



- SKG***
- Resistance cambriolage de la protection de cylindre es supérieur à la norme de SKG*** (> 20kN)
- Plaque interieur avec vis invisible
- Inox mat brossé
- Incl. 2 set de vis pour EP 37-56 mm
- Béquille à commander séparatement



- SKG***
- Einbruchwiderstand der Kernziehschutz übersteigt SKG*** Norm (>20kN)
- Innenschild mit verdeckter Schrauben
- Edelstahl matt gebürstet
- Einschl. 2 Schraubensätze für TS 37-56 mm
- Drücker separat bestellen



- SKG***
- Burglary resistance of cylinder protector supersedes SKG*** norm (>20kN)
- Interior plate with concealed screw fixing
- Satin stainless steel
- Incl. 2 screw sets for doorthickness 37-56 mm
- Order lever separately



		72 mm	26451/72
		92 mm	26451/92

	0980
--	------

	0984
--	------

	0985
--	------

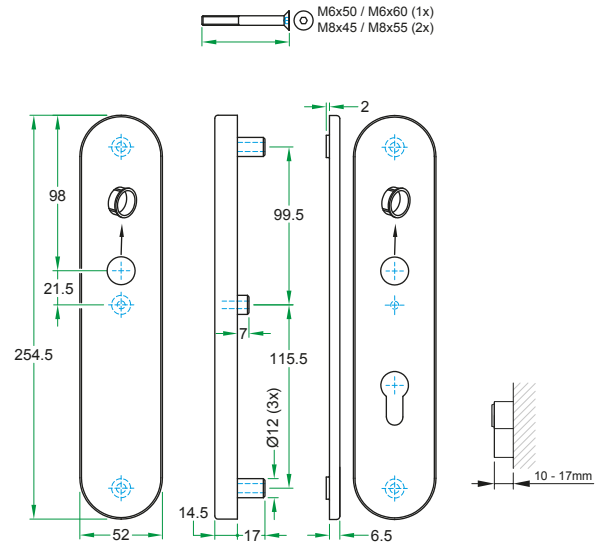
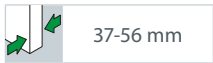
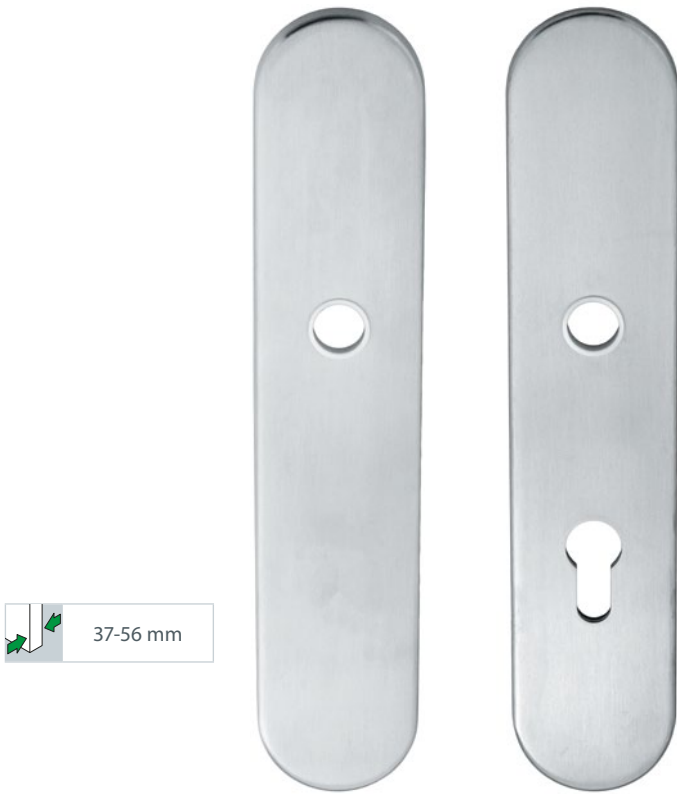

4B



- SKG ***
- Inbraakweerstand kerntrekbeveiliging overtreft SKG*** norm (> 20kN)
- Binnenschild met verdeckte schroefbevestiging
- RVS mat geborsteld
- Incl. 2 schroeven sets t.b.v. DD 37-56 mm
- Deurkruk separaat bestellen



- SKG***
- Resistance cambriolage de la protection de cylindre es supérieur à la norme de SKG*** (> 20kN)
- Plaque interieur avec vis invisible
- Inox mat brossé
- Incl. 2 set de vis pour EP 37-56 mm
- Béquille à commander séparément



- SKG***
- Einbruchwiderstand der Kernziehschutz übersteigt SKG*** Norm (>20kN)
- Innenschild mit verdeckter Schrauben
- Edelstahl matt gebürstet
- Einschl. 2 Schraubensätze für TS 37-56 mm
- Drücker separat bestellen



- SKG***
- Burglary resistance of cylinder protector supersedes SKG*** norm (>20kN)
- Interior plate with concealed screw fixing
- Satin stainless steel
- Incl. 2 screw sets for doorthickness 37-56 mm
- Order lever separately



		72 mm	26453/72
		92 mm	26453/92

	0980
--	------

	0984
--	------

	0985
--	------

COMPONENTEN / COMPOSANTS / ZUBEHÖR / COMPONENTS

Veiligheidsbeslag / Quincaillerie de sécurité / Schutzbeschläge / Security Hardware
Binnenschilden / Plaques interieur / Innenschilder / Interior plates

4B

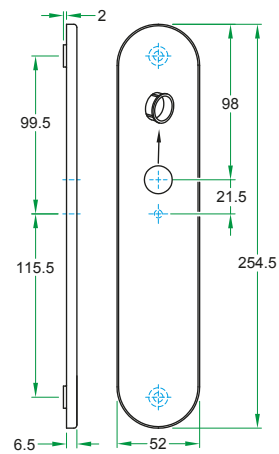
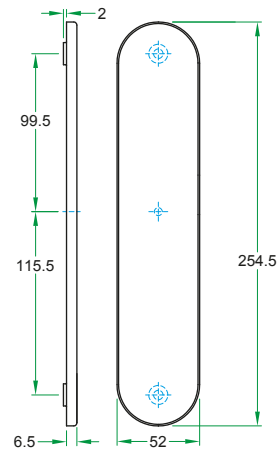

-  **TOP ONDERDELEN** Verlengde stiften en schroeven
-  **TOP ACCESSOIRES** Tiges e vis allongées
-  **TOP ZUBEHÖR** verlängerte Stifte und Schrauben
-  **TOP PARTS** extended spindles and screws



Schroeven
Vis
Schrauben
Screws

Stift
Tige carrée
Stift
Spindle

Artikelnr.
Code d'article
Artikelnr.
Article code

TOP • Knop/kruk SKG3 schilden • Plaques bouton/béquille SKG3 • Knopf/Drücker Schilder SKG3 • Knob/lever plates SKG3

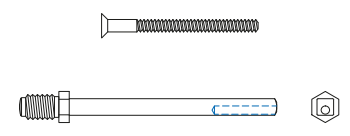
	37-46 mm	inclusief/inclus zuzüglich/included	inclusief/inclus zuzüglich/included	
	47-56 mm	inclusief/inclus zuzüglich/included	inclusief/inclus zuzüglich/included	
	57-66 mm	1x M6 x 70 mm 2x M8 x 60 mm	M12/□8 x 89 mm	TW5766
	70 mm	1x M6 x 80 mm 2x M8 x 70 mm	M12/□8 x 99 mm	TW70
	80 mm	1x M6 x 90 mm 2x M8 x 80 mm	M12/□8 x 125 mm	TW80

4B

TOP • Kruk/kruk SKG3 schilden • Plaques béquille/béquille SKG3 • Drücker/Drücker Schilder SKG3 • Lever/lever plates SKG3

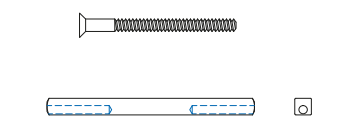
	37-46 mm	inclusief/inclus zuzüglich/included	□8 x 110 mm*	93156
	47-56 mm	inclusief/inclus zuzüglich/included	□8 x 130 mm	93202
	57-66 mm	1x M6 x 70 mm 2x M8 x 60 mm	□8 x 155 mm	TK5766 + 97717



Stift
Tige carrée
Stift
Spindle

Artikelnr.
Code d'article
Artikelnr.
Article code

	38 - 48 mm		□8 x 61 mm	93166
	49 - 59 mm		□8 x 71 mm	93167
	60 - 70 mm		□8 x 82 mm	93168
	49 - 59 mm		□10 x 25 mm / □8 x 46 mm	93213
	60 - 70 mm		□10 x 25 mm / □8 x 57 mm	93214

* Deurkrukparen 0980-0984-0985 zijn standaard voorzien van stift 8 x 110 mm.

* Les béquilles 0980-0984-0985 sont fourni standard avec tige carrée 8 x 110 mm.

* Drückerpaare 0980-0984-0985 sind standard versehen mit Vierkantstift 8 x 110 mm.

* Lever pair 0980-0984-0985 are standard provided with square spindle 8 x 110 mm.



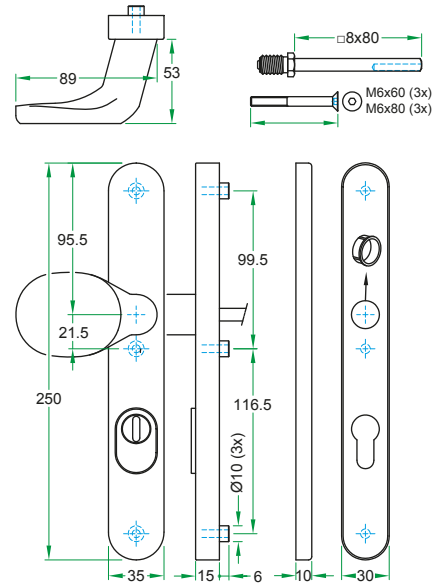
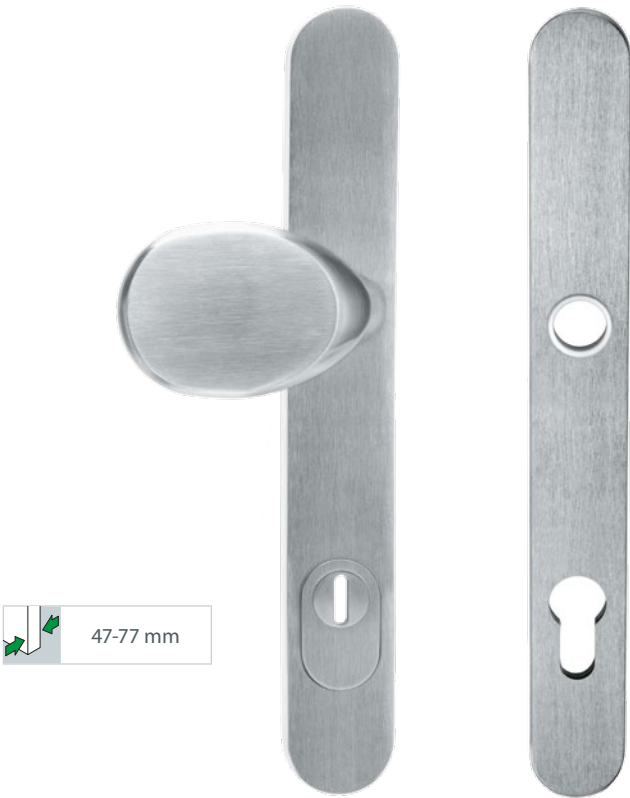

47-77 mm

4C



- SKG***
- Massief RVS buitenschild 35 mm (B)
- Inbraakweerstand kerntrekbeveiliging overtreft SKG*** norm (> 20kN)
- Binnenschild 30 mm(B) met verdeckte schroefbevestiging
- RVS mat geborsteld
- Incl. 2 schroevensets tbv DD 47-77 mm
- Deurkruk separaat bestellen



- SKG***
- Plaque extérieure inox massif 35 mm (L)
- Résistance cambriolage de la protection de cylindre es supérieur à la norme de SKG*** (> 20kN)
- Plaque intérieur 30 mm (L) avec vis invisible
- Inox mat brossé
- Incl. 2 set de vis pour EP 47-77 mm
- Béquille à commander séparément



- SKG***
- Massives Edelstahl Außenschild 35 mm (B)
- Einbruchwiderstand der Kernziehschutz übersteigt SKG*** Norm (>20kN)
- Innenschild 30 mm (B) mit verdeckter Schrauben
- Edelstahl matt gebürstet
- Einschl. 2 Schraubensätze für TS 47-77 mm
- Drücker separat bestellen



- SKG***
- Solid stainless steel exterior plate 35 mm (W)
- Burglary resistance of cylinder protector supersedes SKG*** norm (>20kN)
- Interior plate 30 mm(W) with concealed screw fixing
- Satin stainless steel
- Incl. 2 screw sets for doorthickness 47-77 mm
- Order lever separately



		72 mm	26300/72
		92 mm	26300/92

	0981
--	------

	0982
--	------

	0983
--	------

4C

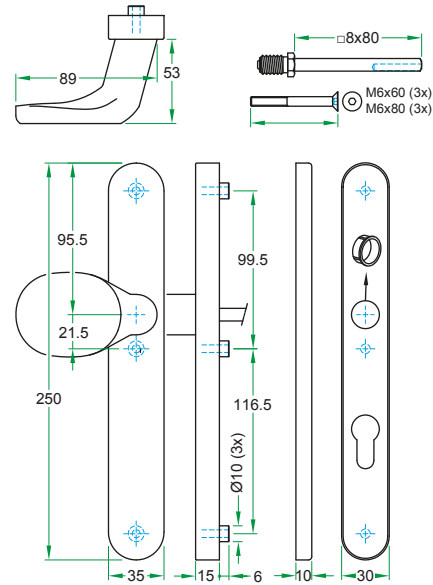
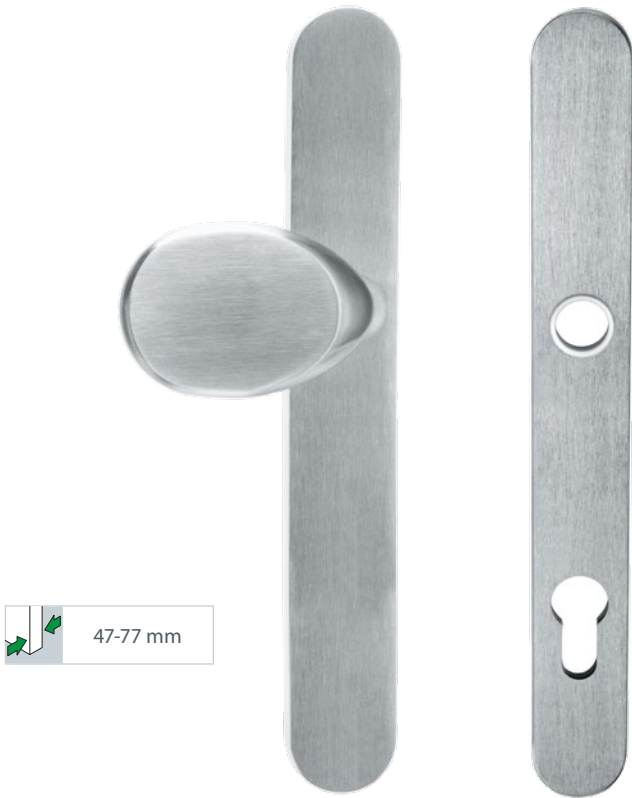

47-77 mm



- SKG***
- Massief RVS buitenschild 35 mm (B)
- Binnenschild 30 mm(B) met verdeckte schroefbevestiging
- RVS mat geborsteld
- Incl. 2 schroeven sets tbv DD 47-77 mm
- Deurkruk separaat bestellen



- SKG***
- Plaque extérieure inox massif 35 mm (L)
- Plaque intérieur 30 mm (L) avec vis invisible
- Inox mat brossé
- Incl. 2 set de vis pour EP 47-77 mm
- Béquille à commander séparément



- SKG***
- Massives Edelstahl Außenschild 35 mm (B)
- Innenschild 30 mm (B) mit verdeckter Schrauben
- Edelstahl matt gebürstet
- Einschl. 2 Schraubensätze für TS 47-77 mm
- Drücker seperat bestellen



- SKG***
- Solid stainless steel exterior plate 35 mm (W)
- Interior plate 30 mm(W) with concealed screw fixing
- Satin stainless steel
- Incl. 2 screw sets for doorthickness 47-77 mm
- Order lever seperately



		72 mm	26302/72
		92 mm	26302/92

	0981
--	------

	0982
--	------

	0983
--	------

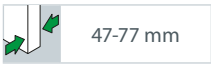
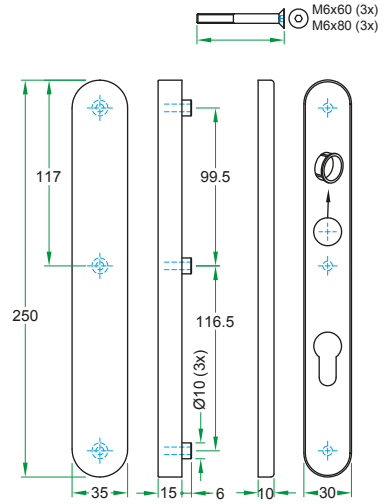

- SKG***
- Massief RVS buitenschild 35 mm (B)
- Binnenschild 30 mm(B) met verdeckte schroefbevestiging
- RVS mat geborsteld
- Incl. 2 schroeven sets tbv DD 47-77 mm
- Deurkruk separaat bestellen



- SKG***
- Plaque extérieur inox massif 35 mm (L)
- Plaque intérieur 30 mm (L) avec vis invisible
- Inox mat brossé
- Incl. 2 set de vis pour EP 47-77 mm
- Béquille à commander séparément



- SKG***
- Massives Edelstahl Außenschild 35 mm (B)
- Innenschild 30 mm (B) mit verdeckter Schrauben
- Edelstahl matt gebürstet
- Einschl. 2 Schraubensätze für TS 47-77 mm
- Drücker seperat bestellen



- SKG***
- Solid stainless steel exterior plate 35 mm (W)
- Interior plate 30 mm(W) with concealed screw fixing
- Satin stainless steel
- Incl. 2 screw sets for doorthickness 47-77 mm
- Order lever seperately



		72 mm	26304/72
		92 mm	26304/92

	0981
--	------

	0982
--	------

	0983
--	------

	□ 8 x 61 mm		38 - 48 mm	93166
	□ 8 x 71 mm		49 - 59 mm	93167
	□ 8 x 82 mm		60 - 70 mm	93168
	□ 10 x 25 mm / □ 8 x 46 mm		49 - 59 mm	93213
	□ 10 x 25 mm / □ 8 x 57 mm		60 - 70 mm	93214

4C

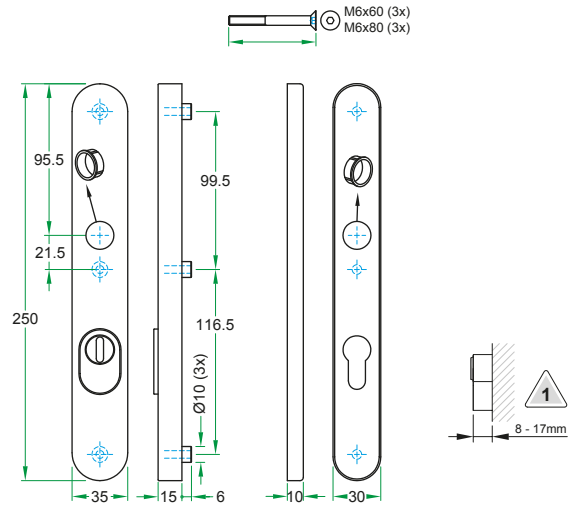
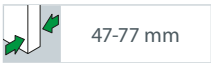
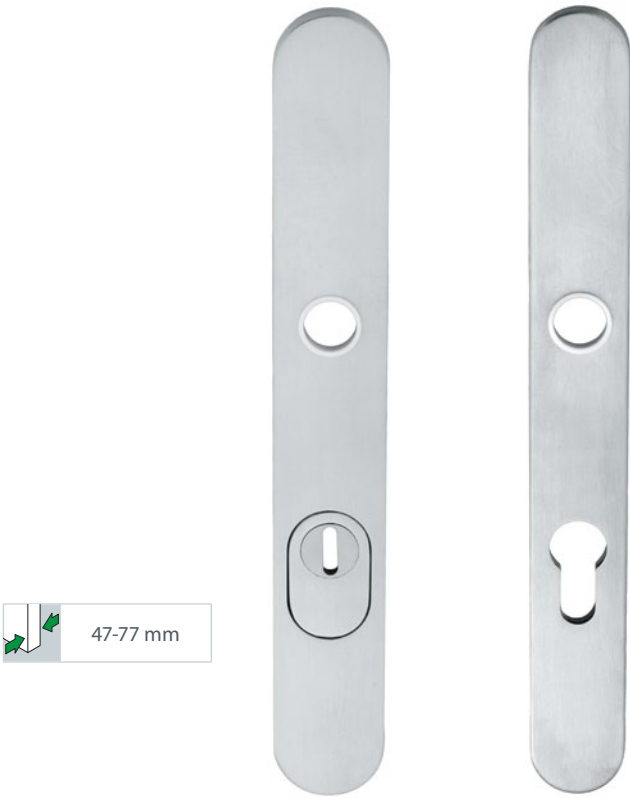

- SKG***
- Massief RVS buitenschild 35 mm (B)
- Inbraakweerstand kerntrekbeveiliging overtreft SKG*** norm (> 20kN)
- Binnenschild 30 mm(B) met verdeckte schroefbevestiging
- RVS mat geborsteld
- Incl. 2 schroeven sets tbv DD 47-77 mm
- Deurkruk separaat bestellen



- SKG***
- Plaque extérieur inox massif 35 mm (L)
- Resistance cambriolage de la protection de cylindre es supérieur à la norme de SKG*** (> 20kN)
- Plaque intérieur 30 mm (L) avec vis invisible
- Inox mat brossé
- Incl. 2 set de vis pour EP 47-77 mm
- Béquille à commander séparément



- SKG***
- Massives Edelstahl Außenschild 35 mm (B)
- Einbruchwiderstand der Kernziehschutz übersteigt SKG*** Norm (>20kN)
- Innenschild 30 mm (B) mit verdeckter Schrauben
- Edelstahl matt gebürstet
- Einschl. 2 Schraubensätze für TS 47-77 mm
- Drücker separat bestellen



- SKG***
- Solid stainless steel exterior plate 35 mm (W)
- Burglary resistance of cylinder protector supersedes SKG*** norm (>20kN)
- Interior plate 30 mm(W) with concealed screw fixing
- Satin stainless steel
- Incl. 2 screw sets for doorthickness 47-77 mm
- Order lever separately



		72 mm	26301/72
		92 mm	26301/92

	0980
--	------

	0984
--	------

	0985
--	------

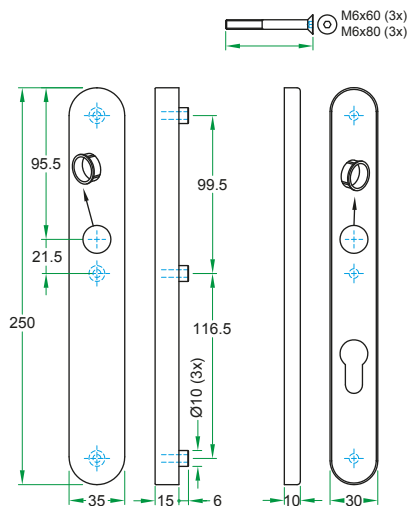

- SKG***
- Massief RVS buitenschild 35 mm (B)
- Binnenschild 30 mm(B) met verdeckte schroefbevestiging
- RVS mat geborsteld
- Incl. 2 schroeven sets tbv DD 47-77 mm
- Deurkruk separaat bestellen



- SKG***
- Plaque extérieur inox massif 35 mm (L)
- Plaque intérieur 30 mm (L) avec vis invisible
- Inox mat brossé
- Incl. 2 set de vis pour EP 47-77 mm
- Béquille à commander séparément



- SKG***
- Massives Edelstahl Außenschild 35 mm (B)
- Innenschild 30 mm (B) mit verdeckter Schrauben
- Edelstahl matt gebürstet
- Einschl. 2 Schraubensätze für TS 47-77 mm
- Drücker separer bestellen



- SKG***
- Solid stainless steel exterior plate 35 mm (W)
- Interior plate 30 mm(W) with concealed screw fixing
- Satin stainless steel
- Incl. 2 screw sets for doorthickness 47-77 mm
- Order lever seperately



		72 mm	26303/72
		92 mm	26303/92

	0980
--	------

	0984
--	------

	0985
--	------

4C

COMPONENTEN / COMPOSANTS / ZUBEHÖR / COMPONENTS

Veiligheidsbeslag / Quincaillerie de sécurité / Schutzbeschläge / Security Hardware
Binnenschilden / Plaques interieur / Innenschilder / Interior plates

4C

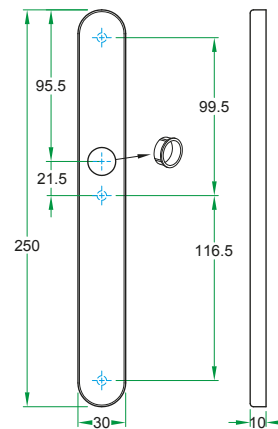
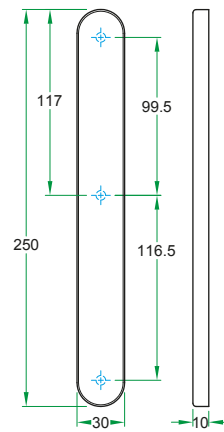

-  **PRIO ONDERDELEN Verlengde stiften en schroeven**
-  **PRIO ACCESSOIRES Tiges e vis allongées**
-  **PRIO ZUBEHÖR verlängerte Stifte und Schrauben**
-  **PRIO PARTS extended spindles and screws**



Schroeven
Vis
Schrauben
Screws

Stift
Tige carrée
Stift
Spindle

Artikelnr.
Code d'article
Artikelnr.
Article code

PRIO • Knop/kruk SKG3 schilden • Plaques bouton/béquille SKG3 • Knopf/Drücker Schilder SKG3 • Knob/lever plates SKG3

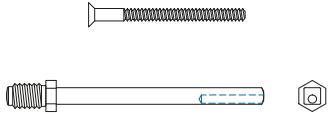
	47-57 mm	inclusief/inclus zuzüglich/included	inclusief/inclus zuzüglich/included	
	67-77 mm	inclusief/inclus zuzüglich/included	inclusief/inclus zuzüglich/included	
	39-46 mm	3x M6 x 50 mm	M12/□8 x 80 mm	PW3946
	57-66 mm	3x M6 x 70 mm	inclusief/inclus zuzüglich/included	PW5766
	84-91 mm	3x M6 x 90 mm	M12/□8 x 120 mm	PW8491

4C

PRIO • Kruk/kruk SKG3 schilden • Plaques béquille/béquille SKG3 • Drücker/Drücker Schilder SKG3 • Lever/lever plates SKG3

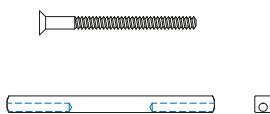
	47-57 mm	inclusief/inclus zuzüglich/included	□ 8 x 130 mm	93111
	67-77 mm	inclusief/inclus zuzüglich/included	□ 8 x 150 mm	
	39-46 mm	3x M6 x 50 mm	□ 8 x 110 mm*	PK3946 + 93156
	57-66 mm	3x M6 x 70 mm	□ 8 x 140 mm	PK5766 + 93156-140
	84-91 mm	3x M6 x 90 mm	□ 8 x 155 mm	PK8491 + 97717



Stift
Tige carrée
Stift
Spindle

Artikelnr.
Code d'article
Artikelnr.
Article code

	38 - 48 mm		□ 8 x 61 mm	93166
	49 - 59 mm		□ 8 x 71 mm	93167
	60 - 70 mm		□ 8 x 82 mm	93168
	49 - 59 mm		□ 10 x 25 mm / □ 8 x 46 mm	93213
	60 - 70 mm		□ 10 x 25 mm / □ 8 x 57 mm	93214

* Deurkrukparen 0980-0984-0985 zijn standaard voorzien van stift 8 x 110 mm.

* Les béquilles 0980-0984-0985 sont fourni standard avec tige carrée 8 x 110 mm.

* Drückerpaare 0980-0984-0985 sind standard versehen mit Vierkantstift 8 x 110 mm.

* Lever pair 0980-0984-0985 are standard provided with square spindle 8 x 110 mm.

COMPONENTEN / COMPOSANTS / ZUBEHÖR / COMPONENTS

Deurkruk / Béquille / Drücker / Lever

4C



	0980
	0981



- Geschikt voor veiligheidsbeslag
- RVS mat geborsteld



- Apte pour quincaillerie de sécurité
- Inox mat brossé



- Geeignet für Schutzbeschläge
- Edelstahl matt gebürstet



- Suitable for security hardware
- Satin stainless steel

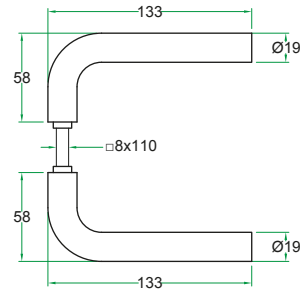

- Geschikt voor veiligheidsbeslag
- RVS mat geborsteld



- Apte pour quincaillerie de sécurité
- Inox mat brossé



- Geeignet für Schutzbeschläge
- Edelstahl matt gebürstet



- Suitable for security hardware
- Satin stainless steel



	0984
	0982

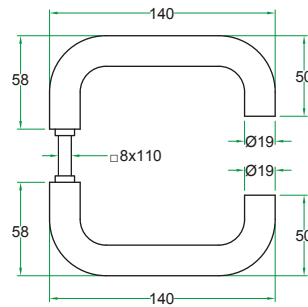

- Geschikt voor veiligheidsbeslag
- RVS mat geborsteld



- Apte pour quincaillerie de sécurité
- Inox mat brossé



- Geeignet für Schutzbeschläge
- Edelstahl matt gebürstet



- Suitable for security hardware
- Satin stainless steel



	0985
	0983

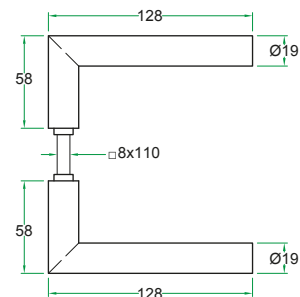

COMPONENTEN / COMPOSANTS / ZUBEHÖR / COMPONENTS

Knop / Bouton / Knopf / Knob

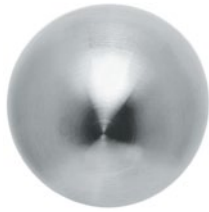

- Draaibaar
- RVS mat geborsteld



- Tournant
- Inox mat brossé



- Drehbar
- Edelstahl matt gebürstet



- Turnable
- Brushed satin stainless steel

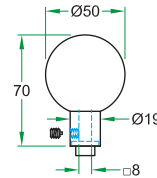

96181/R

4C



- Draaibaar
- RVS mat geborsteld



- Tournant
- Inox mat brossé



- Drehbar
- Edelstahl matt gebürstet



- Turnable
- Brushed satin stainless steel

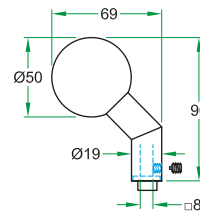

96183/R



- Draaibaar
- RVS mat geborsteld



- Tournant
- Inox mat brossé



- Drehbar
- Edelstahl matt gebürstet



- Turnable
- Brushed satin stainless steel

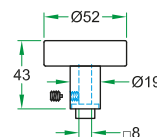

67102/R



NOVA

Veiligheidsrozetten / Rosaces de sécurité / Schutzrosetten / Security roses

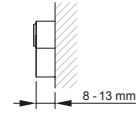
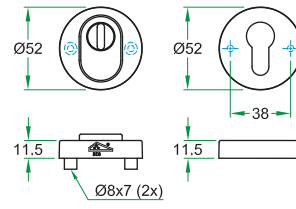

4D

	ES92351
--	----------------

	40-47 mm	65-72 mm
--	----------	----------



- SKG***
- Inbraakweerstand kerntrekbeveiliging overtreft SKG*** norm (>20kN)
- DIN 18257 ES1
- Binnenrozet met verdeckte schroefbevestiging
- RVS mat geborsteld
- Incl. 2 schroeven sets M5 t.b.v DD 40-47 mm en DD 65-72 mm



- SKG***
- Resistance cambriolage de la protection de cylindre es supérieur à la norme de SKG*** (>20kN)
- DIN 18257 ES1
- Rosace interieur avec vis invisible
- Inox mat brossé
- Incl. 2 set de vis M5 pour EP 40-47 mm et EP 65-72 mm



- SKG***
- Einbruchwiderstand der Kernziehschutz SKG*** Norm (>20kN)
- DIN 18257 ES1
- Innenrosette mit verdeckter Schrauben
- Edelstahl matt gebürstet
- Einschl. 2 Schraubensätze M5 für TS 40-47 mm und TS 65-72 mm



- SKG***
- Burglary resistance of cylinder protector supersedes SKG*** Norm (>20kN)
- DIN 18257 ES1
- Interior rose with invisible screws
- Satin stainless steel
- Incl. 2 screw sets M5 for DT 40-47 mm and DT 65-72 mm

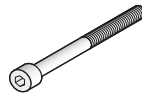

Schroeven
Vis
Schrauben
Screws

Artikelnr.
Code d'article
Artikelnr.
Article code

50-57,5 mm	M5 x 60 mm	93175
60-67,5 mm	M5 x 70 mm	93173
70-77,5 mm	M5 x 80 mm	93176
80-87 mm	M5 x 90 mm	93174

	ES92351
	93291

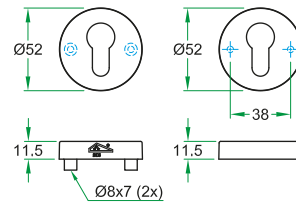

4D

① ①	ES92349
-----	---------

	40-47 mm	65-72 mm
--	----------	----------



- SKG***
- Inbraakweerstand kerntrekbeveiliging overtreft SKG*** norm (>20kN)
- DIN 18257 ES1
- Binnenrozet met verdeckte schroefbevestiging
- RVS mat geborsteld
- Incl. 2 schroeven sets M5 t.b.v DD 40-47 mm en DD 65-72 mm



- SKG***
- Resistance cambriolage de la protection de cylindre es supérieur à la norme de SKG*** (>20kN)
- DIN 18257 ES1
- Rosace interieur avec vis invisible
- Inox mat brossé
- Incl. 2 set de vis M5 pour EP 40-47 mm et EP 65-72 mm



- SKG***
- Einbruchwiderstand der Kernziehschutz SKG*** Norm (>20kN)
- DIN 18257 ES1
- Innenrosette mit verdeckter Schrauben
- Edelstahl matt gebürstet
- Einschl. 2 Schraubensätze M5 für TS 40-47 mm und TS 65-72 mm



- SKG***
- Burglary resistance of cylinder protector supersedes SKG*** Norm (>20kN)
- DIN 18257 ES1
- Interior rose with invisible screws
- Satin stainless steel
- Incl. 2 screw sets M5 for DT 40-47 mm and DT 65-72 mm

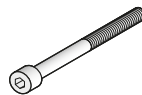

Schroeven
Vis
Schrauben
Screws

Artikelnr.
Code d'article
Artikelnr.
Article code

50-57,5 mm	M5 x 60 mm	93175
60-67,5 mm	M5 x 70 mm	93173
70-77,5 mm	M5 x 80 mm	93176
80-87 mm	M5 x 90 mm	93174

① ①	ES92349
○ ①	93290