

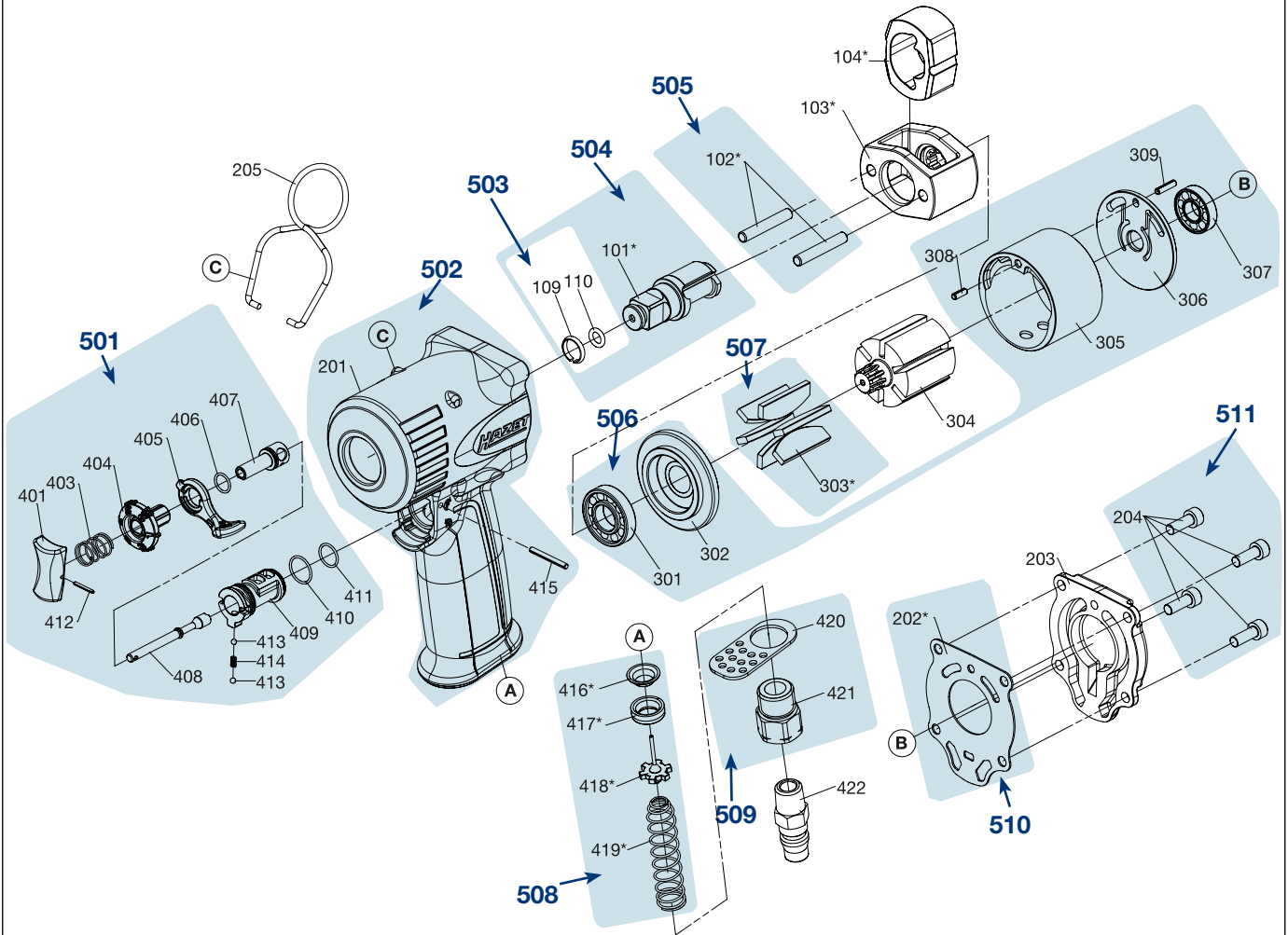

Ersatzteile 9011 M

Spare parts - Pièces de rechange



	HAZET No.	Bezeichnung	Designation	Désignation	
103	9012 M-01	Schlagwerkskorb Inhalt: 103	<i>Hammer frame</i> <i>Contents: 103</i>	<i>Cage de mécanisme de frappe</i> <i>Contenu: 103</i>	1
104	9012 M-02	Jumbo-Hammer Inhalt: 104	<i>Jumbo hammer</i> <i>Contents: 104</i>	<i>Marteau jumbo</i> <i>Contenu: 104</i>	1
203	9012 M-03	Hintere Gehäuse- Abdeckung Inhalt: 203	<i>Rear housing cover</i> <i>Contents: 203</i>	<i>Capot de boîtier arrière</i> <i>Contenu: 203</i>	1
205	9012 M-04	Haken Inhalt: 205	<i>Hook</i> <i>Contents: 205</i>	<i>Crochet</i> <i>Contenu: 205</i>	1
304	9012 M-05	Rotor Inhalt: 304	<i>Rotor</i> <i>Contents: 304</i>	<i>Rotor</i> <i>Contenu: 304</i>	1
501	9012 M-19/14	Abzugshebel, komplett Inhalt: 401, 403, 404, 405, 406, 407, 408, 409, 410, 411, 412, 413 (2x), 414	<i>Trigger complete</i> <i>Contents: 401, 403, 404, 405, 406, 407, 408, 409, 410, 411, 412, 413 (2x), 414</i>	<i>Levier de tirage complète</i> <i>Contenu: 401, 403, 404, 405, 406, 407, 408, 409, 410, 411, 412, 413 (2x), 414</i>	14
502	9011 M-08/2	Gehäuse Inhalt: 201, 415	<i>Housing</i> <i>Contents: 201, 415</i>	<i>Boîtier</i> <i>Contenu: 201, 415</i>	2

	HAZET No.	Bezeichnung	Designation	Désignation	
503	9011 M-09/2	Ring-Satz	<i>Ring set</i>	<i>Jeu d'anneaux</i>	2
		Inhalt: 109, 110	<i>Contents: 109, 110</i>	<i>Contenu: 109, 110</i>	
504	9011 M-010/3	Vierkant mit Ring-Satz	<i>Anvil with ring set</i>	<i>Carré avec jeu d'anneaux</i>	3
		Inhalt: 101, 109, 110	<i>Contents: 101, 109, 110</i>	<i>Contenu: 101, 109, 110</i>	
505	9012 M-011/2	Stift	<i>Hammer pin</i>	<i>Goupille</i>	2
		Inhalt: 102 (2x)	<i>Contents: 102 (2x)</i>	<i>Contenu: 102 (2x)</i>	
506	9012 M-020/7	Zylindereinheit komplett	<i>Cylinder unit complete</i>	<i>Unité de vérin complète</i>	7
		Inhalt: 301, 302, 305, 306, 307, 308, 309	<i>Contents: 301, 302, 305, 306, 307, 308, 309</i>	<i>Contenu: 301, 302, 305, 306, 307, 308, 309</i>	
507	9012 M-013/6	Lamellen	<i>Blades</i>	<i>Lamelles</i>	6
		Inhalt: 303 (6x)	<i>Contents: 303 (6x)</i>	<i>Contenu: 303 (6x)</i>	
508	9012 M-015/4	Ventileinheit	<i>Valve set</i>	<i>Unité de soupape</i>	4
		Inhalt: 416, 417, 418, 419	<i>Contents: 416, 417, 418, 419</i>	<i>Contenu: 416, 417, 418, 419</i>	
509	9012 M-016/2	Lufteinlass	<i>Air inlet</i>	<i>Admission d'air</i>	2
		Inhalt: 420, 421	<i>Contents: 420, 421</i>	<i>Contenu: 420, 421</i>	
510	9012 M-017/10	Dichtungs-Satz	<i>Gasket set</i>	<i>Joint d'étanchéité</i>	10
		Inhalt: 202 (10x)	<i>Contents: 202 (10x)</i>	<i>Contenu: 202 (10x)</i>	
511	9012 M-018/4	Gehäuseschraube	<i>Bolt</i>	<i>Vis de boîtier</i>	4
		Inhalt: 204 (4x)	<i>Contents: 204 (4x)</i>	<i>Contenu: 204 (4x)</i>	

Zur Bestellung und für Rückfragen wenden Sie sich bitte an unsere Service-Abteilung:

 +49 (0) 21 91/7 92 355

 +49 (0) 21 91/7 92 523

 service-center@hazet.de

 hazet.de/de/home/service/pneumatikmaschinen/

 hazet.de/ersatzteil-shop/









service/
pneumatikmaschinen



Ersatzteil-shop

HAZET - WERK Hermann Zerver GmbH & Co. KG •  10 04 61 • 42804 Remscheid • GERMANY

 Güldenwerther Bahnhofstraße 25 - 29 • 42857 Remscheid •  hazet.de •  info@hazet.de

 +49 (0) 21 91 / 7 92-0 •  +49 (0) 21 91 / 7 92-375 (National) •  +49 (0) 21 91 / 7 92-400 (International)